

IMPLANT SYSTEM

XCN[®]



IMPLANTOLOGY

PRODUCT CATALOGUE

10th Italian edition
9th English edition



LEONE S.p.a.

Orthodontics and Implantology

Via P. a Quaracchi, 50
50019 Sesto Fiorentino
Firenze ITALY
Phone +39.0553044620
Fax +39.055304405
info@leone.it
www.leone.it

2022

A historic company in the Italian business environment, Leone helped lay the foundations for the birth of modern dentistry almost a century ago. The Group is now made up of realities with a strong vocation for innovation and with a relevant international profile. During the last five years, Leone has moved on to digitization strategies with the design of innovative series of digital-ready products in line with the vision of the company, thus stimulating the modernization of the orthodontic and dental implant sector.



RESEARCH

Most of the remarkable investments of the company are reserved to the Centre for Biotechnological Research "Marco Pozzi", which is located inside the company. Studies on materials, surfaces and technical analysis for new products are carried out here. The collaboration with either Italian or foreign Universities and the Faculties of Engineering and Medicine and Surgery in Florence is very close. Training stages and scientific research are developed for the preparation of graduation thesis.



PRODUCTION

Engineers, mechanical and technical experts are making part of the manufacturing staff. Working side by side with the Centre for Biotechnological Research "Marco Pozzi" and making use of the most advanced technology, they are able to carry out the components of the two product ranges: orthodontics and implantology. All the innovations introduced in the production steps and the features of finished products are the result of consistent and in-depth studies as well as of remarkable investments.



QUALITY PRODUCT CONTROL

The high quality of Leone production is the result of sophisticated manufacturing processes and accurate quality control in compliance with UNI EN ISO 9001, ISO 13485 and ISO 13485 MDSAP international regulations for regulatory requisitions in Australia, Brazil, Canada, Japan and USA.



TECHNICAL AND COMMERCIAL ASSISTANCE

Contact your dealer in your country as a reference. You will find the comprehensive list under the section "distributors" in our website **www.leone.it**



CUSTOMER SERVICE

Leone is working non stop to satisfy the customer's expectations and is represented with dealers in 60 countries. A careful pre-sale and post-sale customer assistance is provided by qualified technical and commercial staff to meet any requirement.



WAREHOUSE

Finished and semi-finished products are stocked and organized by vertical lift automatic cabinets allowing a rationalization of the space and a fully computer based processing of the orders. Standard orders are shipped within 24 hours in Italy and 5-6 working days in the foreign country.



EDUCATION TRAINING UPGRADE

Equipped with every multimedia device, the facility of 1000 sq.m is entirely dedicated to lectures and to the spreading of new therapeutic techniques. Training course, live demonstrations and cultural events are being held for either Italian or foreign specialists.

In this catalogue you can find QR codes storing multimedia contents which can be downloaded directly on your smartphone. You can download free QR reader applications (e.g. www.i-nigma.com) except for the connecting charges. Videos are also available on our web-site: www.leone.it/english/implantology

COMPETENCE AND RELIABILITY

The Leone dealers worldwide are under constant professional improvement thanks to the technical assistance received by engineers and technical experts at Leone to get specific information on the products and solve any eventual problems from the customers.

XCN[®]

IMPLANT SYSTEM



PRODUCT CATALOGUE

XCN [®] implants	pages 7..15
Accessories for surgical planning	page 16
Surgical instruments	pages 17..26
Surgical kits	pages 27..34
Products for soft tissue conditioning and prosthetic components	pages 35..43
Abutments for cement-retained prosthesis and impression accessories	pages 45..57
ExaConnect for single-unit screw-retained prosthesis and accessories	pages 59..66
MUA for multi-unit screw-retained prosthesis and accessories	pages 67..76
Conometric-retained prosthesis and accessories	pages 77..82
Abutments for attachment-retained prosthesis and accessories	pages 83..88
Information gingival height GH of XCN [®] abutments	page 89
Prosthetic and laboratory instruments	pages 91..98
Demonstration and informative material	pages 99..100
3DLeone	pages 167..168

SURGICAL PROCEDURE

pages 101..122

Disclaimer

and implant treatment planning

pages 102..104

Packaging and removal
of XCN® implants pages 105..107

Drilling protocols for
XCN® implants pages 108..112

1) Preparation of the implant site pages 113..114

2) Placement of the implant pages 115..116

3) Healing options page 117

3.1) Two-stage surgical procedure - first and second stage pages 118..119

3.2) One-stage surgical procedure page 120

3.3) Transgingival healing with ExaConnect Plus page 121

3.4) Transgingival healing with MUA Plus page 122

PROSTHETIC PROCEDURE

pages 123..150

Disclaimer and premise

page 124

Conventional prosthetic workflows

Cement-retained single crown page 125
Screw-retained single crown pages 126..127
Cement-retained bridge page 128
Screw-retained bridge/bar page 129
All-on-four page 130
Fixed conometric-retained bridge/full-arch pages 131..133
Removable prosthesis on ball-head abutments page 134
Removable conometric-retained prosthesis page 135

Digital prosthetic workflows

Cement-retained single crown pages 136..137
Cement-retained bridge/single crown pages 138..139
Screw-retained single crown pages 140..143
Screw-retained bridge/bar pages 144..146
Fixed conometric-retained bridge/full-arch pages 147..149

LEONE MONOIMPLANTS FOR O-RING OVERDENTURE

pages 151..166

Monoimplants for O-ring Overdenture pages 151..154
Surgical instruments pages 155..156
Surgical and prosthetic procedures pages 157..166
Disclaimer and implant treatment planning pages 158..159
Preparation of the implant site pages 160..161
Packaging of the monoimplant page 162
Insertion of the monoimplant pages 163..164
Preparation of the mobile prosthesis pages 165..166

ALPHABETICAL INDEX

pages 170..171

IMPLANT SYSTEM

XCN[®]

IMPLANTS



IMPLANT TYPES

The Leone implant system offers four different implant macro-designs:

- **Classix implant** featuring a cylindrical geometry;
- **Max Stability implant** having a root-form geometry and a more aggressive thread design;
- **2.9 Narrow implant** featuring a maximum diameter of only 2.9 mm;
- **6.5 Short implant** with a length reduced to 6.5 mm.

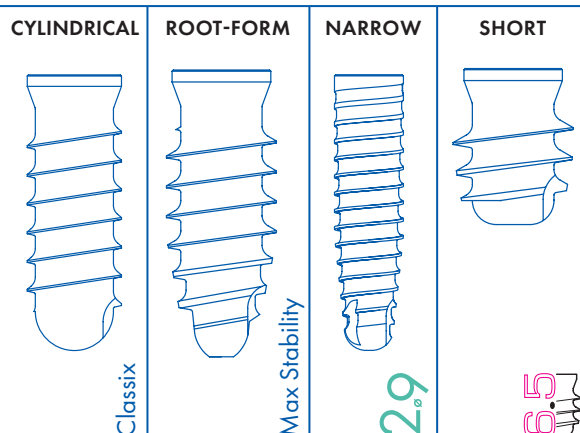

IMPLANT-ABUTMENT MORSE TAPER CONNECTION

The distinctive feature of the system is the Leone implant-abutment connection, a combination of two geometries:

- **screwless self-locking Morse taper*** and internal hexagon.
- The Morse taper and the absence of the abutment screw guarantee:
- no micro-movements;
 - no micro-gaps, thus perfect bacterial seal;
 - option of subcrestal placement of the implants;
 - outstanding resistance to masticatory loads.
- The result is a highly reliable system, very similar to the natural tooth.

Bibliography: www.leone.it in the section "Scientific publications"

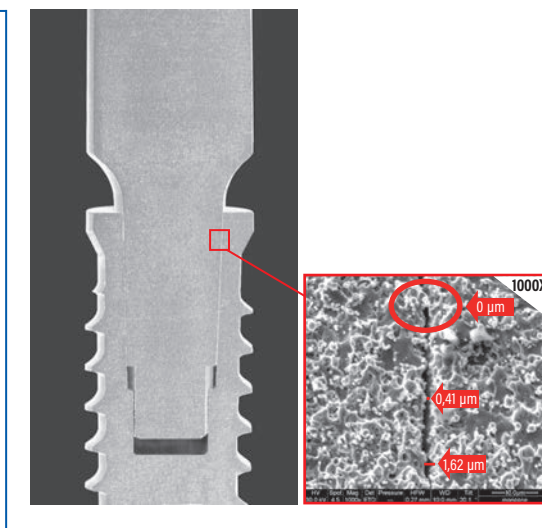

PLATFORM SWITCHING

The "Platform Switching" design of the transmucosal portion increases the height and the volume of the soft tissue, thus sealing and protecting the underlying bone. In combination with the properties of the Morse taper connection, it promotes the maintenance of the periimplant tissues over time, as proven by long-term clinical studies.

Bibliography: www.leone.it in the section "Scientific publications"

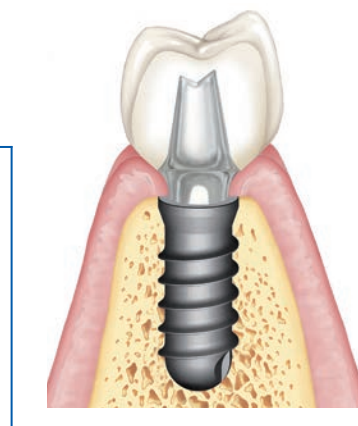

*International UNI ISO 296

HRS SURFACE

The HRS (High Rutile Surface) surface is obtained through an exclusive sandblasting process which produces an implant surface roughness $R_a \approx 2,5 \mu\text{m}$ ($R_a \approx 1 \mu\text{m}$ for 2.9 Narrow implants). The following cleaning treatments (passivation and decontamination) remove any organic and inorganic residues from the surface.

Bibliography: www.leone.it in the section "Scientific publications"

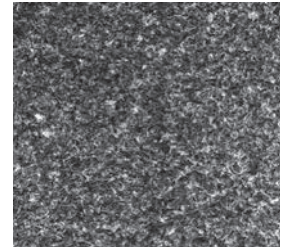

IMPLANT PACKAGING

The sterile packaging includes a vial inside a blister, wrapped in a paper box.

The box design ensures easy storage and identification of the product thanks to the large colour-coded label with detailed product information clearly visible when the boxes are stacked.

Each package includes multilingual instructions for use and four peel labels.



COLOUR CODING OF IMPLANTS

Each implant is identified by a colour-coded carrier.

The carrier is made of titanium core and a biopolymer outer shell in the colour code of the implant.

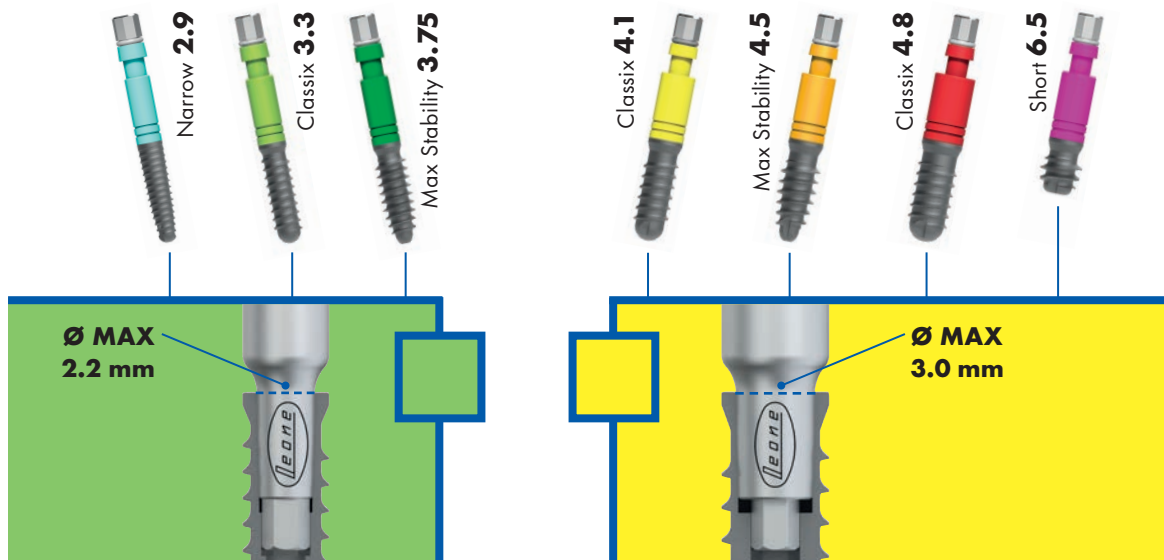

COLOUR CODING OF THE PROSTHETIC CONNECTIONS

Small diameter implants have a **green** colour-coded prosthetic connection (connection diameter 2.2 mm), whereas larger diameter implants have a **yellow** colour-coded prosthetic connection (connection diameter 3.0 mm). Connection diameter is the maximum size of the Morse taper.

CLASSIX IMPLANTS

Ideal for

- medium and high bone density
- limited horizontal bone availability
- crestal sinus lift

Features

- made of medical grade 5 titanium
- flared coronal portion
- cylindrical geometry
- atraumatic thread design (Standard ISO 5835)
- two-lobed hemispherical apex
- 3 implant diameters (3.3 - 4.1 - 4.8 mm)
- 4 lengths (8 - 10 - 12 - 14 mm)

Sterile package

- 1 implant mounted on carrier
- 1 cover cap in biopolymer





Classix implants **Ø 3,3 mm**
connection diameter 2.2 mm colour code: green

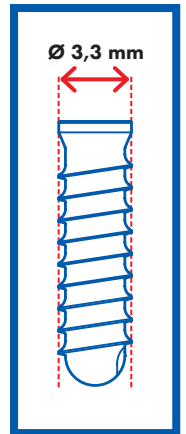

Ø (mm)	3,3	3,3	3,3	3,3
length (mm)	8	10	12	14

REF **110-3308-02 110-3310-02 110-3312-02 110-3314-02**



Classix implants **Ø 4,1 mm**
connection diameter 3.0 mm colour code: yellow

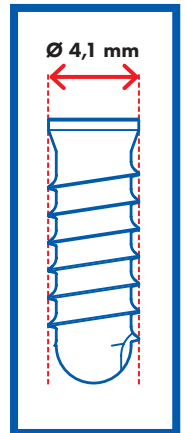

Ø (mm)	4,1	4,1	4,1	4,1
length (mm)	8	10	12	14

REF **110-4108-02 110-4110-02 110-4112-02 110-4114-02**



Classix implants **Ø 4,8 mm**
connection diameter 3.0 mm colour code: yellow

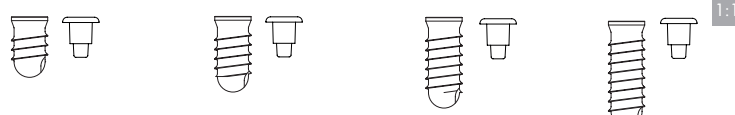
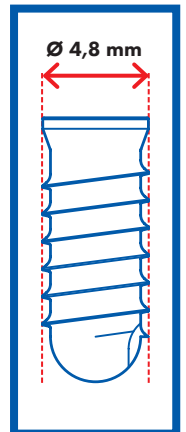

Ø (mm)	4,8	4,8	4,8	4,8
length (mm)	8	10	12	14

REF **110-4808-30 110-4810-30 110-4812-30 110-4814-30**

MAX STABILITY IMPLANTS

Ideal for

- poor bone density
- immediate post-extraction implant placement
- immediate loading
- ridge split

Features

- made of medical grade 5 titanium
- flared coronal portion
- root-form geometry
- over 50% increase in thread height
- two-lobed conical apex
- 2 implant diameters (3.75 - 4.5 mm)
- 4 lengths (8 - 10 - 12 - 14 mm)

Sterile package

- 1 implant mounted on carrier
- 1 cover cap in biopolymer





Max Stability implants **Ø 3,75 mm**
connection diameter 2.2 mm colour code: green

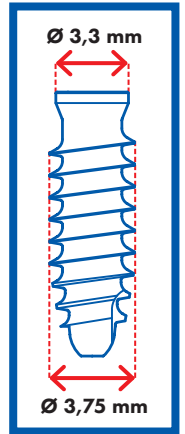

Ø (mm)	3,75	3,75	3,75	3,75
length (mm)	8	10	12	14
REF	110-3808-02	110-3810-02	110-3812-02	110-3814-02



Max Stability implants **Ø 4,5 mm**
connection diameter 3.0 mm colour code: yellow

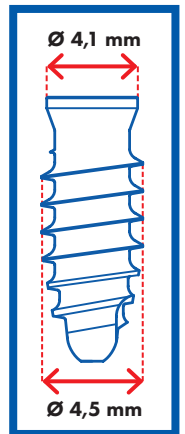

Ø (mm)	4,5	4,5	4,5	4,5
length (mm)	8	10	12	14
REF	110-4508-02	110-4510-02	110-4512-02	110-4514-02

2.9 NARROW IMPLANTS

Ideal for

- narrow ridges and limited interdental spaces
- upper lateral incisors
- lower central and lateral incisors

Features

- made of medical grade 5 titanium
- cylindrical coronal portion
- conical geometry
- fine thread pitch
- tri-lobed conical apex
- implant diameter of 2.9 mm
- 3 lengths (10 - 12 - 14 mm)

Sterile package

- 1 implant mounted on carrier
- 1 cover cap in biopolymer



6.5 SHORT IMPLANT

Ideal for

- limited vertical bone availability

Features

- made of medical grade 5 titanium
- flared coronal portion
- cylindrical geometry
- 125% increase in thread height
- two-lobed flat apex
- implant diameter of 5 mm
- length of 6.5 mm

Sterile package

- 1 implant mounted on carrier
- 1 cover cap in biopolymer





Narrow implants **Ø 2,9 mm**
connection diameter 2.2 mm colour code: green

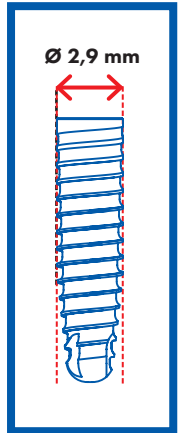

Ø (mm)
length (mm)



2,9

10

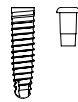

2,9

12

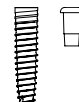

2,9

14

1:1

REF

110-2910-02

110-2912-02

110-2914-02



6.5 Short Implant **Ø 5 mm**
connection diameter 3.0 mm colour code: yellow

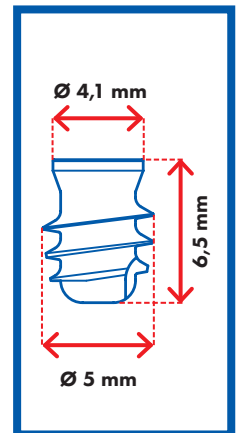

Ø (mm)
length (mm)



5

6,5

1:1

REF

110-5065-02

TEMPLATE

To guide the clinician in the choice of the right implant: technical drawings show implants in 3 scales to match possible distortions created by the X-ray unit used for the radiographs:

- actual dimensions 1:1
- dimensions increased by 10%
- dimensions increased by 25%

REF **156-2003-00** Template for CLASSIX implants

REF **156-2003-02** Template for 6.5 SHORT implant

REF **156-2003-04** Template for MAX STABILITY implants

REF **156-2003-05** Template for 2.9 NARROW implants

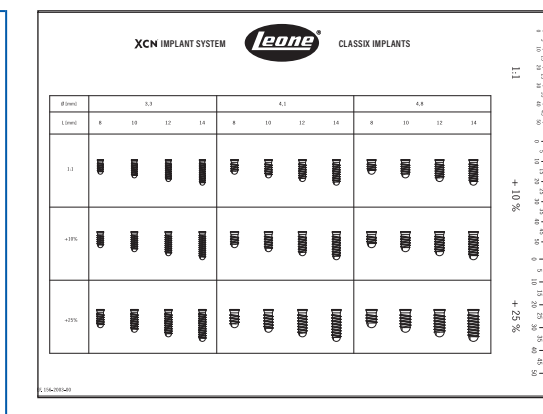

LEONE IMPLANTS IN THE DIGITAL LIBRARIES

The Leone implant system is included in the libraries of the most popular dental software for implant treatment planning and 3D radiographic diagnostics.

ALL-ON-FOUR SURGICAL GUIDE

- made of stainless steel
- to guide the clinician in the angulation of implants in case of All-on-four or All-on-six techniques
- must be positioned in a hole created with the 2.2 mm pilot drill
- supplied non sterile

Pack content:

- 1 guide
- 1 hex key



REF **156-2005-00**

LEONE GUIDED SURGERY

The most widely used 3D planning software programs have 3D files of the Leone system in their libraries, allowing the planning of implant positions based on anatomical conformation and specific prosthetic needs.

Based on the project, it will be possible to realize a CAD-CAM surgical guide that permits the use of the innovative ZERO1 drill (*patented*) for the realization of the osteotomy with maximum operational simplicity, safety and great precision.



IMPLANT SYSTEM

XCN[®]

**SURGICAL
INSTRUMENTS**



BURS AND DRILLS

Features

- made of stainless steel with high resistance to wear and corrosion
- autoclavable

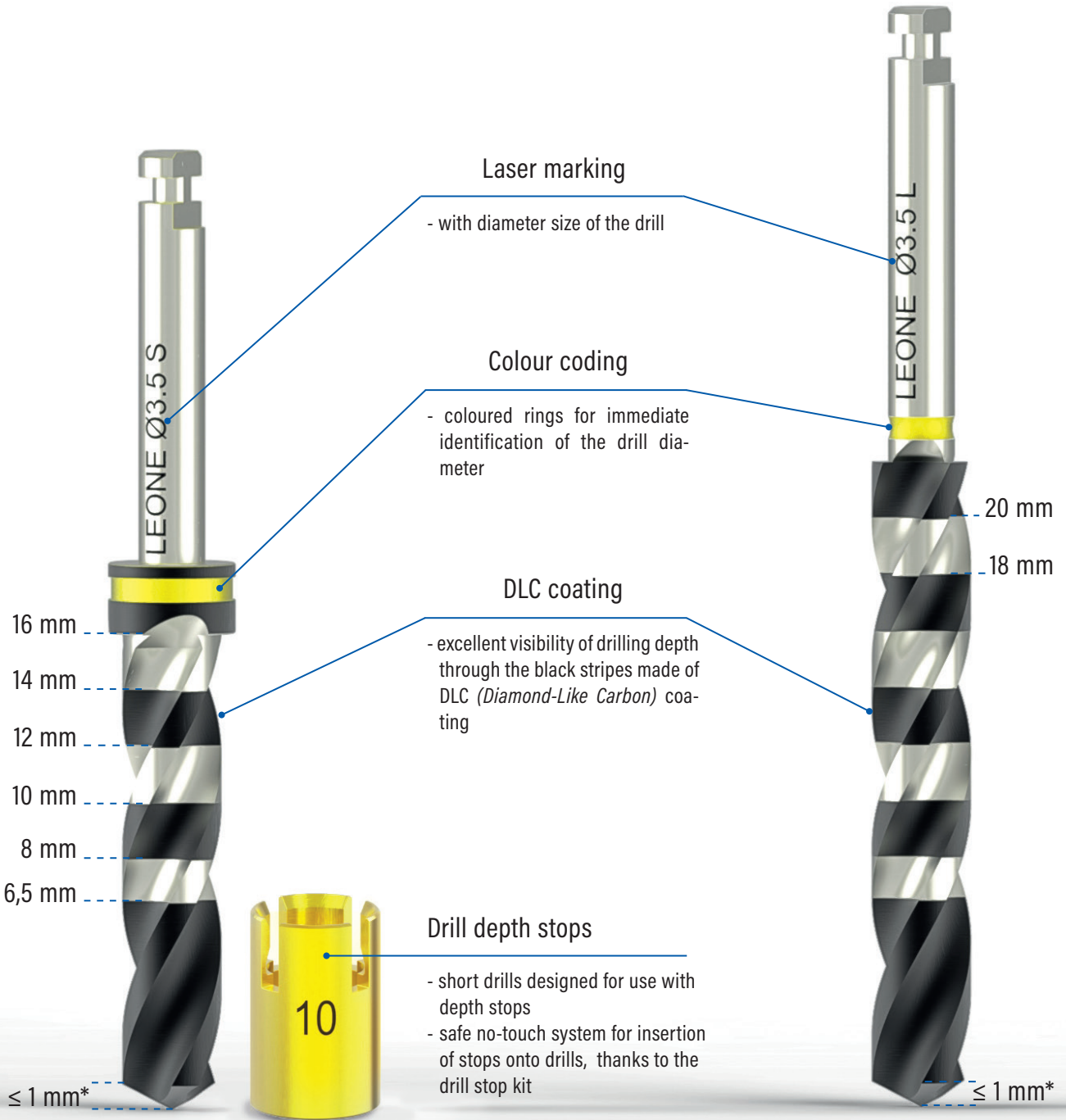

Cutting instruments used more than 20 times or worn out must be replaced.

*The drilling depth for pilot and twist drills is calculated not including the length of the tip (up to 1 mm max).

LANCE DRILL ROUND BUR

- to mark the cortical bone for the subsequent drills
- Pack of 1**



Ø 1,9 mm

L 30 mm



Ø 1,9 mm

L 34 mm



1:1

REF

151-1930-02

151-1934-01

PILOT DRILLS

- to create the pilot hole
- can also use short drills with depth stop
- Pack of 1**



Ø 2,2 mm

L 33 mm



Ø 2,2 mm

L 39 mm



1:1

REF

151-2216-52

151-2222-42

TWIST DRILLS

- to allow the widening of the implant site up to the relevant size
- can also use short drills with depth stop
- Pack of 1**

Ø 2,8 mm



L 33 mm

Ø 2,8 mm



L 39 mm

Ø 3,5 mm



L 33 mm

Ø 3,5 mm



L 39 mm

Ø 4,2 mm



L 33 mm

Ø 4,2 mm



L 39 mm

1:1

REF **151-2816-53** **151-2822-43** **151-3516-53** **151-3522-43** **151-4216-53** **151-4222-43**

TWIST DRILLS FOR HARD BONE

- specifically developed for Max Stability implants
- to avoid excessive insertion torque forces in case of hard bone
- **two colour-coded marks** to differentiate them from the other twist drills
- can also use short drills with depth stop

Pack of 1

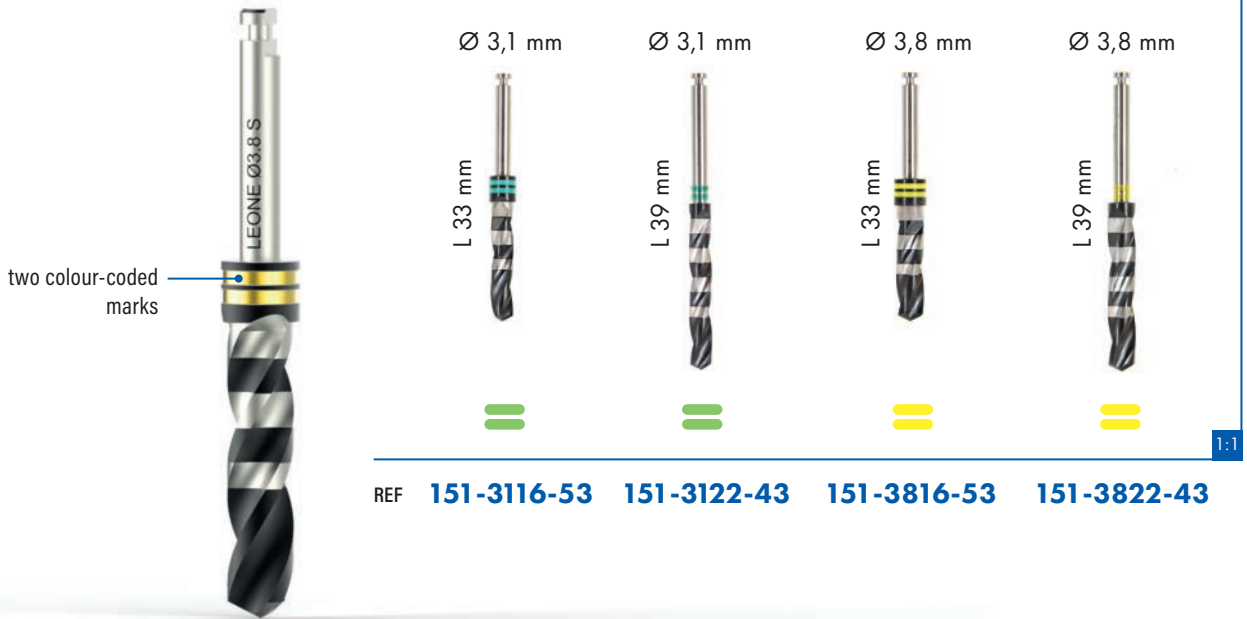

COUNTERSINKS

- to shape the osteotomy for the flared coronal portion of the implant
- for use at the end of the surgical sequence

Pack of 1

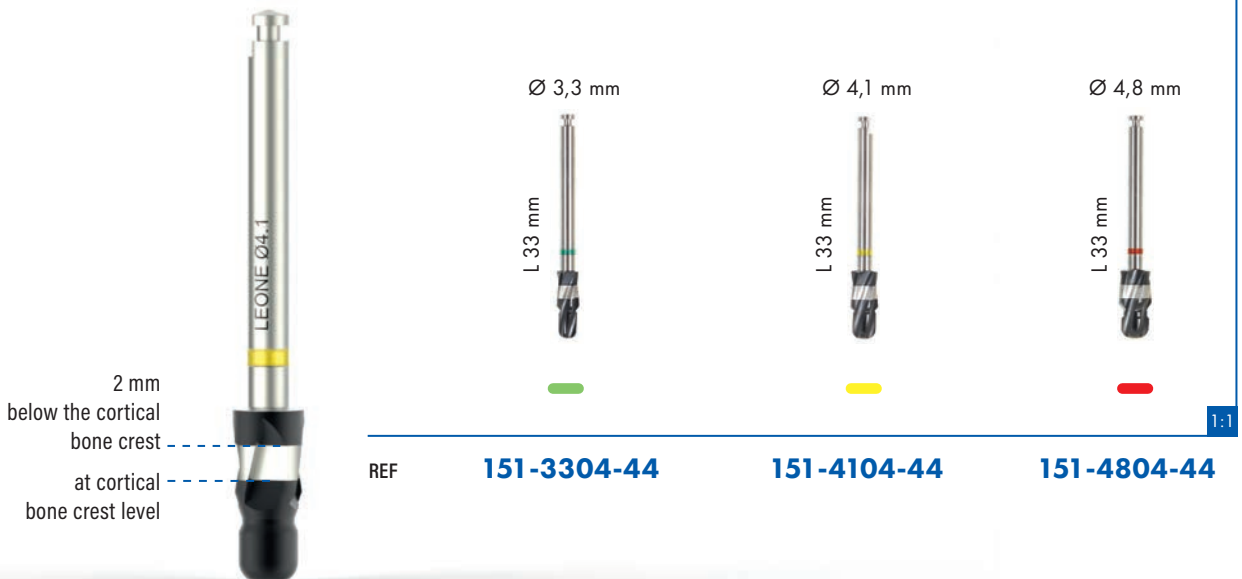

DRILL STOP KIT*

- kit made of aluminium
- depth stops made of medical grade 5 titanium
- for a reliable control of drilling depth during the implant site preparation
- for short pilot and twist drills
- drilling depth marked on each depth stop
- anodized stops for easy identification
- no-touch insertion of the depth stop directly from the drill tip with the help of the drill stop kit
- easy removal of the depth stop, thanks to the special slot on the drill stop kit and the dedicated tool
- fully autoclavable

Pack content:

- 5 depth stops \varnothing 2,2 mm:
L 6,5 - L 8 - L 10 - L 12 - L 14 mm
- 5 depth stops \varnothing 2,8/3,1 mm:
L 6,5 - L 8 - L 10 - L 12 - L 14 mm
- 5 depth stops \varnothing 3,5/3,8 mm:
L 6,5 - L 8 - L 10 - L 12 - L 14 mm
- 5 depth stops \varnothing 4,2 mm:
L 6,5 - L 8 - L 10 - L 12 - L 14 mm
- 1 PEEK tool for stop removal

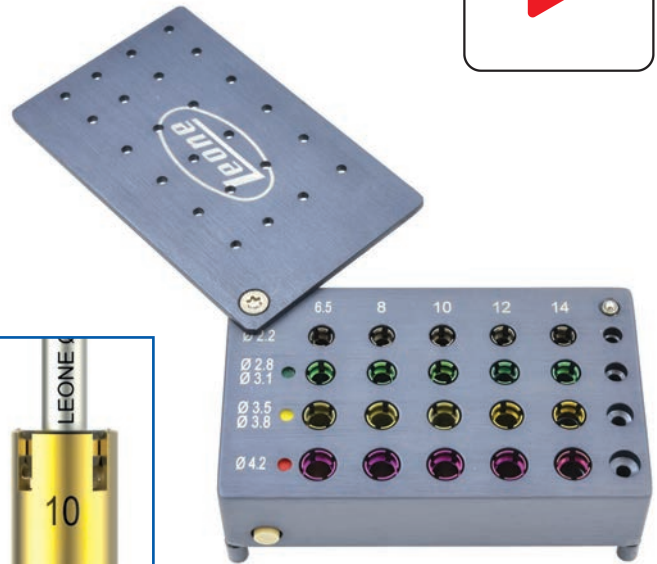

REF **156-0003-00**

DEPTH STOPS

- made of medical grade 5 titanium
- refills for drill stop kit
- autoclavable

Pack content:

- 1 depth stop 6,5 mm
- 1 depth stop 8 mm
- 1 depth stop 10 mm
- 1 depth stop 12 mm
- 1 depth stop 14 mm



for drill

\varnothing 2,2 mm

\varnothing 2,8 mm
 \varnothing 3,1 mm

\varnothing 3,5 mm
 \varnothing 3,8 mm

\varnothing 4,2 mm

REF

156-2216-05

156-2816-05

156-3516-05

156-4216-05

*PATENTED

PILOT DRILLS WITH INTEGRATED DEPTH STOP

- to create the pilot hole
- with integrated depth stop made in one piece with the drill body

Pack of 1



REF **151-2208-12** **151-2210-12** **151-2212-12** **151-2214-12**

DRILL EXTENSION

- made of stainless steel
- to increase the total length of the drills by 16 mm
- autoclavable

Pack of 1



REF **156-1019-00**

TAPS FOR CLASSIX IMPLANTS

- made of stainless steel
- designed for the preparation of the implant site in case of high bone density
- colour-coded
- autoclavable

Pack of 1



REF **152-3321-00** **152-4121-00** **152-4821-00**

TAPS FOR 6.5 SHORT IMPLANT

- made of stainless steel
- tap "A" for the preparation of implant site for 6.5 Short implant
- tap "B" for the preparation of implant site for 6.5 Short implant in case of high bone density after tapping with bone tap "A"
- two marks differentiate tap "B" from tap "A"
- autoclavable

Pack of 1

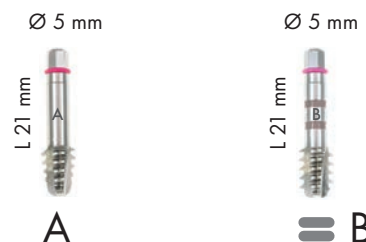

REF **152-5021-01**

152-5021-02

CONNECTING RINGS

- made of elastomeric material
- replacement part for taps and instruments
- autoclavable

Pack of 5

- REF **152-0000-01**
- REF **152-0000-02**
- REF **152-0000-03**
- REF **152-0000-04**
- REF **156-1002-02**

HIGH TORQUE DRIVERS

- made of stainless steel
- to screw in or unscrew implants when the carrier is not strong enough to transmit the force applied
- two versions:
 - green** for 2.2 mm connection
 - yellow** for 3.0 mm connection
- can withstand torque up to 160 Ncm
- replace when used more than 50 times
- autoclavable

Pack of 1



REF **156-1033-00**

156-1041-00

1:1

HANDPIECE ADAPTER

- made of stainless steel
- to screw in or unscrew implants with the contra-angle handpiece
- to use taps with the contra-angle handpiece
- do not use with a torque value higher than 50 Ncm
- autoclavable

Pack of 1



REF **156-1002-01**

1:1

EXTENSION FOR INSTRUMENTS

- made of medical grade 5 titanium
- to extend the overall length of carriers, drivers and taps
- autoclavable

Pack of 1



REF **156-1002-00**

1:1

RATCHET

- made of medical grade 5 titanium
- for use with taps, carriers and drivers
- two-way function instrument to screw in or unscrew implants
- do not disassemble the instrument
- autoclavable

Pack of 1



1:1

REF **156-1014-00**

SURGICAL HAND SCREWDRIVER

- made of medical grade 5 titanium
- for use with taps, carriers and drivers
- with a hole for the placement of a safety leash
- autoclavable

Pack of 1



1:1

REF **156-1001-01**

PARALLELING PIN

- made of medical grade 5 titanium
- designed to ascertain parallelism of the implant site with natural teeth and/or with adjacent implant sites
- Ø 2.2 mm at one end, Ø 2.8 mm at the other end
- with a hole for the placement of a safety leash
- autoclavable

Pack of 1



1:1

REF **156-2001-00**

DEPTH GAUGE

- made of medical grade 5 titanium
- designed to verify the depth of the implant site
- Ø 2.2 mm
- with a hole for the placement of a safety leash
- autoclavable

Pack of 1



1:1

REF **156-2002-00**

INSTRUMENT FOR COVER CAPS

- made of medical grade 5 titanium
- designed for placement and removal of cover caps
- suitable for extraction of the healing cap GH 1.5 after unlocking
- with a hole for the placement of a safety leash
- autoclavable

Pack of 1



1:1

REF **156-1003-00**

HEX HEAD EXTRACTOR FOR HEALING CAPS

- made of stainless steel
- to unlock the healing cap and thus permit its removal
- hexagon on both ends for easy use in all situations
- autoclavable

Pack of 1



1:1

REF **156-1006-00**

TITANIUM BASIN

- made of medical grade 5 titanium
- safe support for titanium instruments or products
- autoclavable

Pack of 1



1:1

REF **156-1009-01**

MEASURING PIN FOR GINGIVAL HEIGHT

- made of medical grade 5 titanium
- to detect the height of the soft tissues and parallelism of implant sites
- Ø 2,2 mm
- with a hole for the placement of a safety leash
- autoclavable

Pack of 1



1:1

REF **156-2004-00**

MUCOSA PUNCH FOR CONTRA-ANGLE

- made of medical grade 5 titanium
- to punch the mucosa
- with colour code matching the implant diameter
- with references of depth and diameter
- autoclavable

Pack of 1

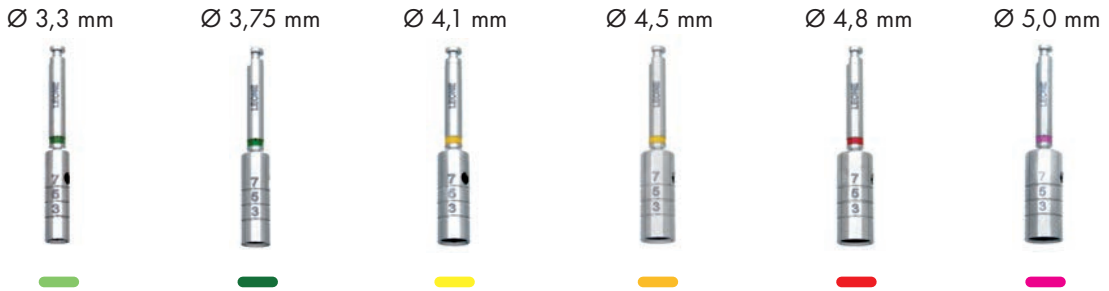

1:1

REF **154-3315-20 154-3815-20 154-4115-20 154-4515-20 154-4815-20 154-5015-20**

BONE PROFILER

- made of stainless steel
- to remove bone coronally to the implant, when the bone walls are interfering with the abutment's emergence profile
- green guide pin for connection diameter 2.2 mm
- yellow guide pin for connection diameter 3.0 mm
- use the instrument for cover caps to insert and remove the guide pin from the implant
- Bone Profiler with diameter reference
- max speed: 50 rpm
- autoclavable

Pack of 1

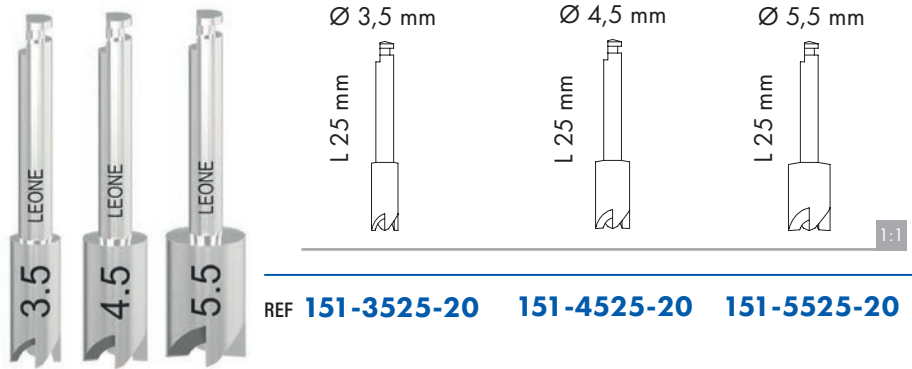

1:1

REF **151-3525-20 151-4525-20 151-5525-20**

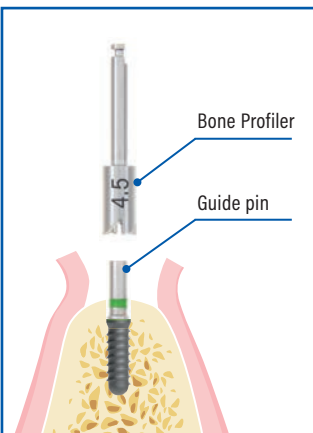

GUIDE PIN

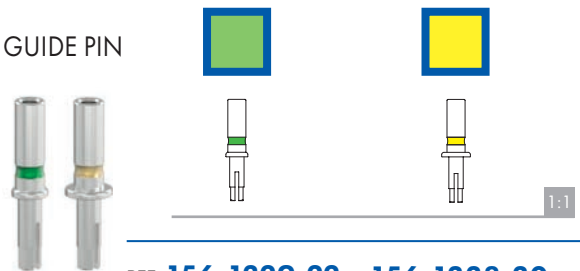

1:1

REF **156-1329-22 156-1338-30**

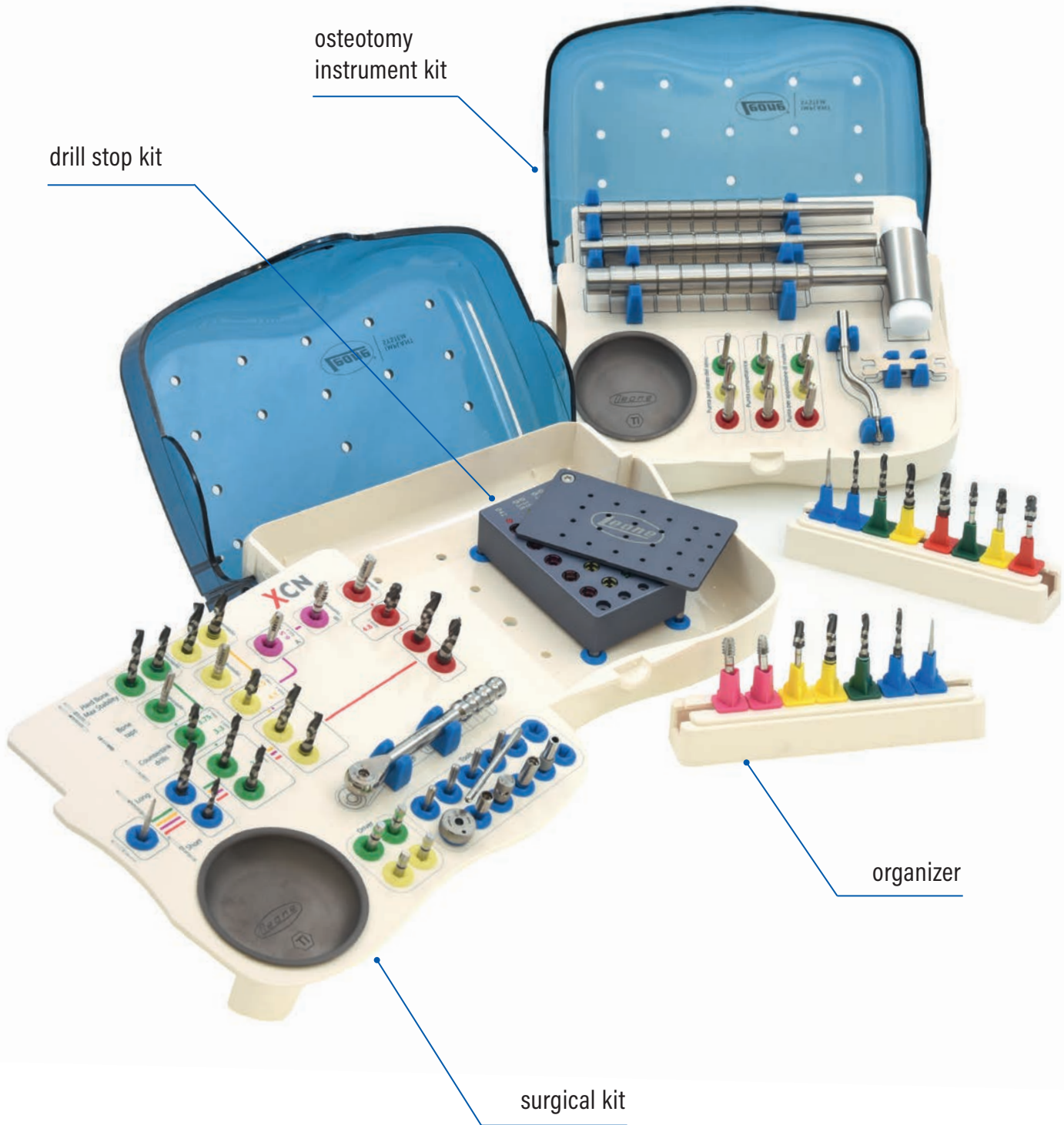

Features

- made of PPSU plastic material
- it includes all the surgical instruments required for treatment with the XCN® implant system
- space-saving
- easy and intuitive colour-coded system indicating the surgical sequence step-by-step for each implant
- tilted position after opening for easy access to instruments
- silicone grommets hold instruments firmly in place
- colour-coded depth stops placed within a special kit
- entirely autoclavable

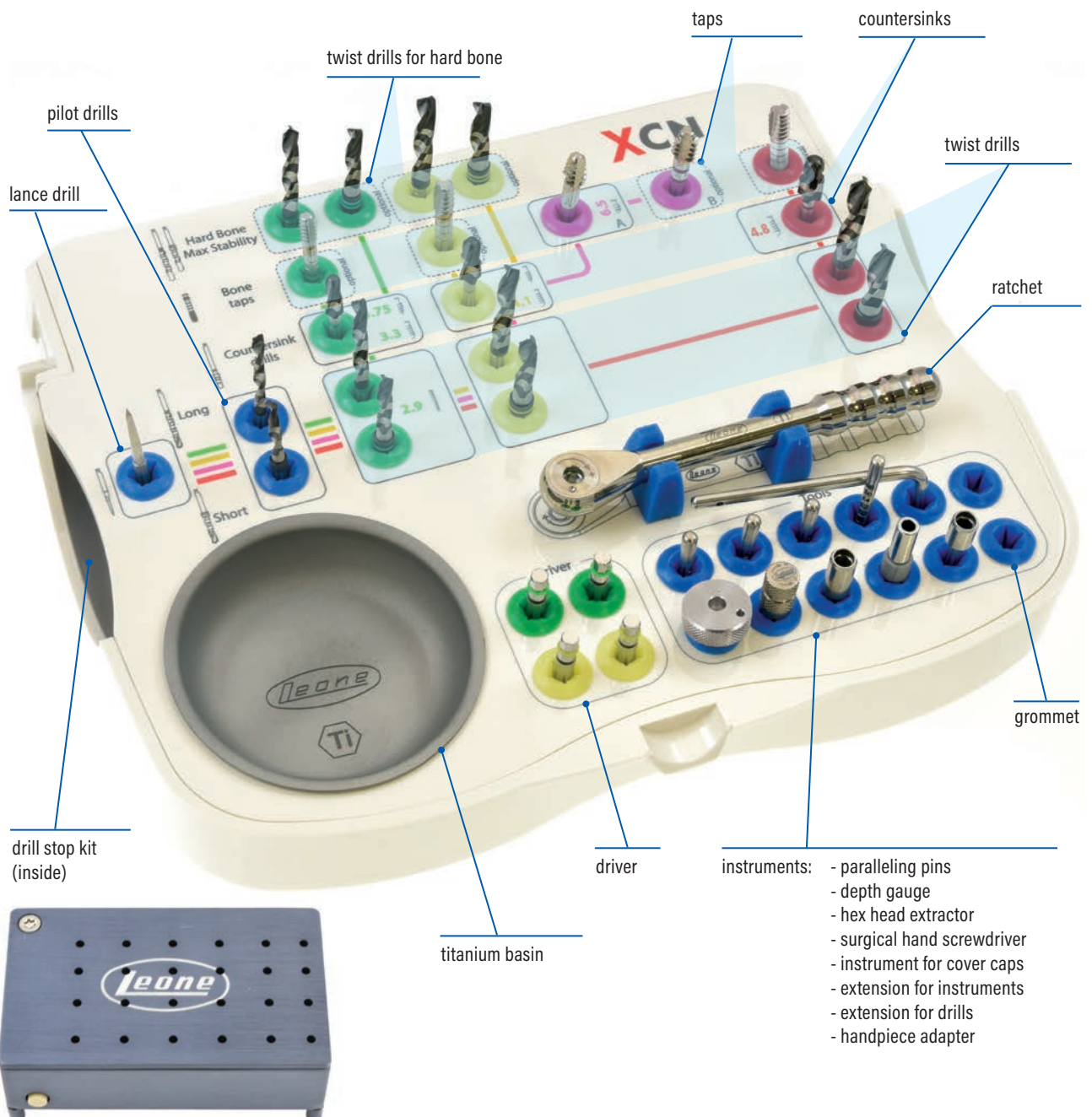

**COMPREHENSIVE
SURGICAL KIT**

REF **156-0066-04**

Kit content

- 1 lance drill
- 2 pilot drills (short and long)
- 6 twist drills Ø 2.8-3.5-4.2 mm (short and long)
- 4 twist drills for hard bone Ø 3.1 e 3.8 mm (short and long) for Max Stability implants
- 3 countersinks Ø 3.3-4.1-4.8 mm
- 3 taps Ø 3.3-4.1-4.8 mm for Classix implants
- 2 taps Ø 5 mm A and B for 6.5 Short implant
- 2 High Torque drivers for connection 2.2 mm
- 2 High Torque drivers for connection 3.0 mm
- 3 paralleling pins Ø 2.2 mm
- 1 depth gauge Ø 2.2 mm
- 1 surgical hand screwdriver
- 1 extension for instruments
- 1 extension for drills
- 1 handpiece adapter
- 1 instrument for cover caps
- 1 hex head extractor
- 1 ratchet
- 1 titanium basin
- 1 drill stop kit
- 20 depth stops



**SURGICAL KIT
SHORT DRILLS, INSTRUMENTS AND DRILL STOP KIT**

REF **156-0066-01**



**SURGICAL KIT
SHORT DRILLS AND INSTRUMENTS**

REF **156-0066-11**



**SURGICAL KIT
WITHOUT CONTENT**

REF **156-0066-00**



GROMMETS

- made of silicone
- refills for the surgical kit and the osteotomy kit
- autoclavable

	Ø 2 mm	REF 156-0002-02	}	Pack of 4
	Ø 2 mm	REF 156-0002-03		
	Ø 2 mm	REF 156-0002-04		
	Ø 2 mm	REF 156-0002-05		
	Ø 2 mm	REF 156-0002-01		
	Ø 4 mm	REF 156-0004-01		Pack of 2

ORGANIZERS

Features

- made of PPSU plastic material
- designed to sterilize and hold on the surgical field only the instruments necessary for the planned surgery
- extremely space-saving
- available in various types according to use (max 8 instruments)
- customizable by the clinician
- entirely autoclavable

Package

- 1 tray
- with instruments mounted on colour-coded supports



ORGANIZER

FOR CLASSIX IMPLANTS Ø 3.3 - 4.1 - 4.8



REF **156-0036-00**

- 151-1930-02 lance drill
- 151-2216-52 pilot drill short
- 151-2816-53 twist drill 2.8 short
- 151-3516-53 twist drill 3.5 short
- 151-4216-53 twist drill 4.2 short
- 151-3304-44 countersink 3.3
- 151-4104-44 countersink 4.1
- 151-4804-44 countersink 4.8

ORGANIZER WITH TAPS

FOR CLASSIX IMPLANTS Ø 3.3 - 4.1 - 4.8



REF **156-0011-00**

- 152-3321-00 tap 3.3
- 152-4121-00 tap 4.1
- 152-4821-00 tap 4.8

ORGANIZER

FOR MAX STABILITY IMPLANTS Ø 3.75 - 4.5



REF **156-0037-00**

- 151-1930-02 lance drill
- 151-2216-52 pilot drill short
- 151-2816-53 twist drill 2.8 short
- 151-3516-53 twist drill 3.5 short
- 151-3304-44 countersink 3.3
- 151-4104-44 countersink 4.1
- 151-3116-53 drill for hard bone 3.1 short
- 151-3816-53 drill for hard bone 3.8 short

ORGANIZER

FOR 6.5 SHORT IMPLANT



REF **156-0038-65**

- 151-1930-02 lance drill
- 151-2216-52 pilot drill short
- 151-2816-53 twist drill 2.8 short
- 151-3516-53 twist drill 3.5 short
- 151-4104-44 countersink 4.1
- 152-5021-01 tap A
- 152-5021-02 tap B

ORGANIZER

FOR 2.9 NARROW IMPLANTS



REF **156-0039-29**

- 151-1930-02 lance drill
- 151-2216-52 pilot drill short
- 151-2816-53 twist drill 2.8 short
- 151-3304-44 countersink 3.3

ORGANIZER

FOR INSTRUMENTS



REF **156-0013-01**

- 156-1002-00 extension for instruments
- 156-1001-01 surgical hand screwdriver
- 156-1019-00 drill extension
- 156-1003-00 instrument for cover caps
- 156-1002-01 handpiece adapter
- 156-2002-00 depth gauge
- 156-1033-00 High Torque driver for connection 2.2
- 156-1041-00 High Torque driver for connection 3.0

ORGANIZER WITHOUT CONTENT



REF **156-0010-01**

OSTEOTOMY INSTRUMENT KIT

REF 156-0040-00

Features

- made of PPSU plastic material
- includes useful instruments for bone condensation techniques and maxillary sinus lift by crestal approach technique
- space-saving
- ergonomic: 9 different tips can be mounted on one single handle either in an upright or angled position
- silicone grommets hold instruments firmly in place
- 3 types of tips:
 - round cylindrical (for sinus lift)
 - convex-cylindrical-conical (for bone condensing)
 - concave-cylindrical-conical (for applying bone graft material)
- tips in 3 different diameters, with colour coding for an immediate identification
- offset adapter for easy use in posterior regions
- entirely autoclavable

Package

- 2 threaded handles
- 1 surgical mallet
- 3 convex bone condenser tips \varnothing 2.7 - 3.4 - 4.1 mm
- 3 concave bone grafting tips \varnothing 2.7 - 3.4 - 4.1 mm
- 3 round sinus lift tips \varnothing 2.7 - 3.4 - 4.1 mm
- 1 tip wrench
- 1 offset adapter for threaded handle
- 1 titanium basin

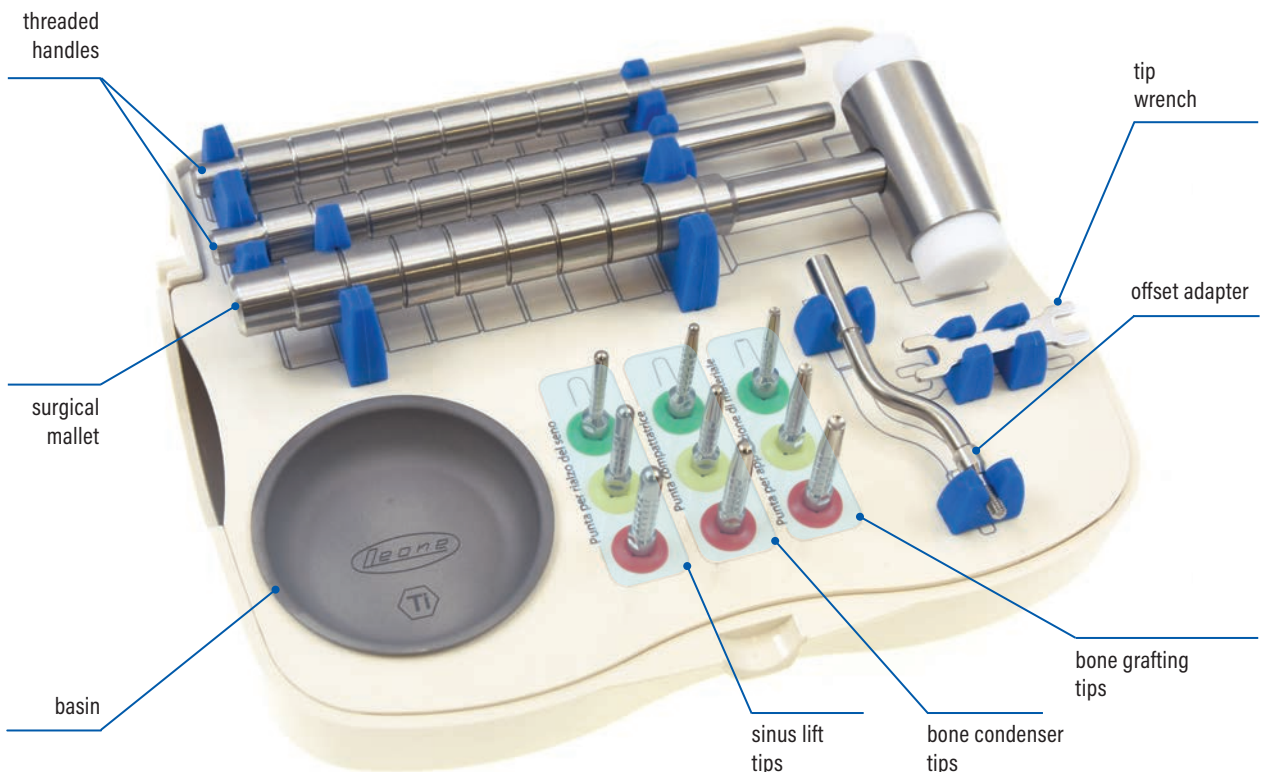

SURGICAL TIPS

- for bone condensing techniques to increase primary stability of the implants and maxillary sinus lift by crestal approach
- with depth marks at 6.5 - 8 - 10 - 12 - 14 - 16 - 18 mm and colour coding

Pack of 1

BONE CONDENSER TIPS

- made of medical grade 5 titanium
- cylindrical-conical with convex apex
- for atraumatic bone condensing
- for the greenstick fracture of the maxillary sinus floor
- Ø 2,2 mm tip specific for the 2.9 Narrow implant
- autoclavable

new

Ø 2,2 mm

Ø 2,7 mm

Ø 3,4 mm

Ø 4,1 mm



REF **156-1011-29** **156-1011-33** **156-1011-41** **156-1011-48**

1:1

SINUS LIFT TIPS

- made of medical grade 5 titanium
- cylindrical shape with rounded apex
- to lift the sinus membrane without damage
- autoclavable

Ø 2,7 mm

Ø 3,4 mm

Ø 4,1 mm



REF **156-1010-33** **156-1010-41** **156-1010-48**

1:1

BONE GRAFTING TIPS

- made of medical grade 5 titanium
- cylindrical-conical with concave apex
- to apply bone graft material during internal maxillary sinus lift
- for bone condensing
- autoclavable

Ø 2,7 mm

Ø 3,4 mm

Ø 4,1 mm



REF **156-1012-33** **156-1012-41** **156-1012-48**

1:1

THREADED HANDLE

- made of stainless steel
- for use with surgical tips
- autoclavable

Pack of 1



1:1

REF **156-1008-00**

OFFSET ADAPTER FOR THREADED HANDLE

- made of stainless steel
- for use with the threaded handle to allow the use of surgical tips in posterior regions
- autoclavable

Pack of 1



1:1

REF **156-1008-05**

TIP WRENCH

- made of stainless steel
- for fixing the surgical tips onto the threaded handle and for their removal
- autoclavable

Pack of 1



1:1

REF **156-1008-07**

SURGICAL MALLET

- made of stainless steel and Teflon
- for gentle tapping on the threaded handle for osteotomy techniques
- autoclavable

Pack of 1



1:1

REF **156-1018-00**

IMPLANT SYSTEM

XCN[®]

PRODUCTS FOR
SOFT TISSUE CONDITIONING AND
PROSTHETIC COMPONENTS



HEALING CAPS STANDARD AND LARGE



Ideal for

- two-stage technique
(insertion after a submerged implant healing period)
- one-stage technique
(insertion immediately after implant placement for transgingival healing)

Features

- made of medical grade 5 titanium
- for soft tissue contouring
- GH 1,5: in two-stage technique instead of the cover cap in case of subcrestal implant placement

Health of periimplant tissues

Due to the self-locking Morse taper connection, the gap between implant and healing cap is essentially zero and therefore the body recognizes the two elements as one single element. The absence of a micro gap also provides a hermetic barrier against bacterial infiltration as demonstrated by in-vitro studies. This promotes the clinical success of the one-stage technique documented by multiple clinical studies.

Bibliography: www.leone.it/english/services/publication-implantology.php

*Courtesy of
Dr. L. Targetti*



Necessary instruments

- selection of the most appropriate cap with the straight Abutment Gauge
- activation of the connection with the abutment seater with straight or offset titanium tip
- unlocking of the connection with the hex head extractor
- **GH 1,5:** after unlocking the connection with the hex head extractor, use the instrument for the cover caps for removal

Sterile package

- 1 healing cap mounted on carrier

Healing cap **standard**

1:1

Ø connection (mm)	2,2	2,2	2,2	2,2
Ø prosthetic platform (mm)	3,3	3,3	3,3	3,3
GH (mm)	1,5	3	5	7
REF	133-3301-33	131-3303-33	131-3305-33	131-3307-33

Healing cap **large**

1:1

Ø connection (mm)		2,2	2,2
Ø prosthetic platform (mm)		4,5	4,5
GH (mm)		3	5
REF		131-3303-45	131-3305-45

Healing cap **standard**

1:1

Ø connection (mm)	3,0	3,0	3,0	3,0
Ø prosthetic platform (mm)	4,1	4,1	4,1	4,1
GH (mm)	1,5	3	5	7
REF	133-4101-41	131-4103-41	131-4105-41	131-4107-41

Healing cap **large**

1:1

Ø connection (mm)		3,0	3,0
Ø prosthetic platform (mm)		5,5	5,5
GH (mm)		3	5
REF		131-4103-55	131-4105-55

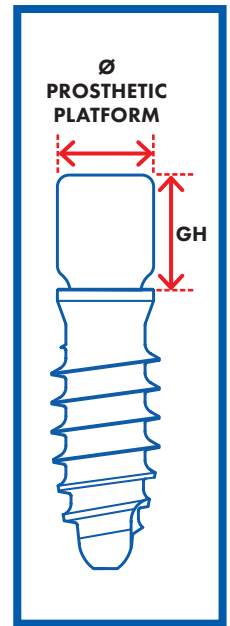

Specific products for soft tissue conditioning in case of screw-retained prostheses are also available:

- ExaConnect Plus for single-unit restorations (pages 61, 63)
- MUA Plus for multi-unit restorations (pages 69, 71).

IMPLANT-ABUTMENT MORSE TAPER CONNECTION

Thanks to the combination of screwless self-locking Morse taper and the internal hexagon, the XCN® implant-abutment connection provides:

- outstanding resistance to masticatory forces
- very low percentage of prosthetic complications
- precise transfer of implant position between dental office and laboratory.

Bibliography: www.leone.it/english/services/publication-implantology.php

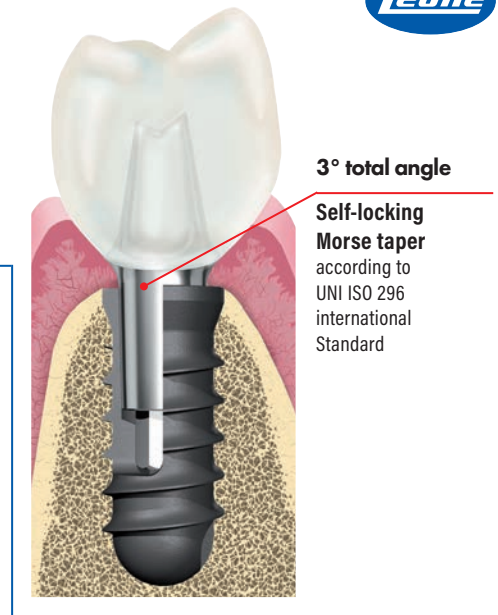

CONNECTION DIAMETERS AND COLOUR CODING

Connection diameter is the maximum size of the Morse taper.

Leone prosthetics is particularly simple since the system has only two connection diameters:

- 2,2 mm (**green** colour code) for small diameter implants
- 3,0 mm (**yellow** colour code) for implants with larger diameters.

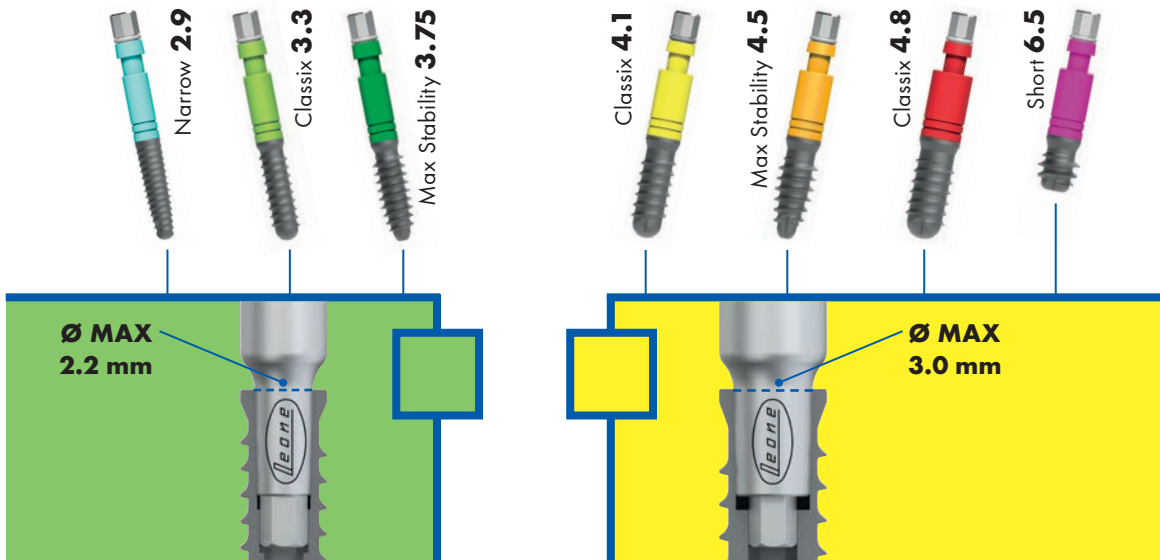

INDEXING OPTIONS

The system offers 3 different indexing options depending on the component selected: **with hexagon, without hexagon and with 360° hexagon.**

Protected by international patents, the XCN® 360° connection is the only system worldwide allowing for indexed abutments with no limits on positioning. This is possible due to the apical hexagon being independent from the rest of the abutment allowing for free positioning of 360°. In this way it is always easy to achieve parallelism, without losing the important index (hexagon).

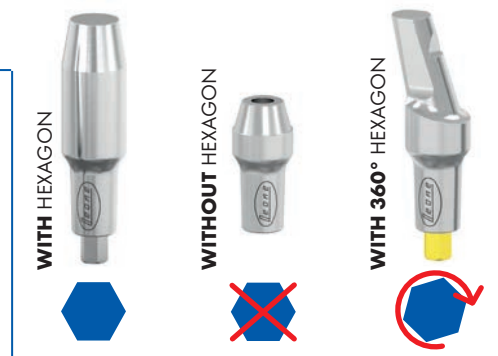

STERILE PROSTHETIC COMPONENTS

The following prosthetic components are available sterile mounted on specific carriers to facilitate immediate loading and the one-stage surgical technique (transgingival healing):

- healing caps, Standard and Large
- ExaConnect Plus with the corresponding healing screw
- MUA Plus with the corresponding healing screw.

CAD-CAM PROSTHETICS

Leone implant system is equipped with the necessary accessories to fabricate, by digital production, cement-retained and screw-retained single teeth and bridges, as well as bars with the most popular CAD-CAM software.

For more information see page 168 or visit www.leone.it/english/implantology

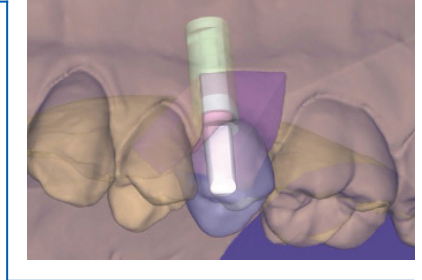

PROSTHETIC VERSATILITY

The Leone implant system offers the possibility to fabricate cement- and screw-retained fixed restorations, fixed and removable conometric-retained restorations, as well as attachment- and bar-retained removable dentures.

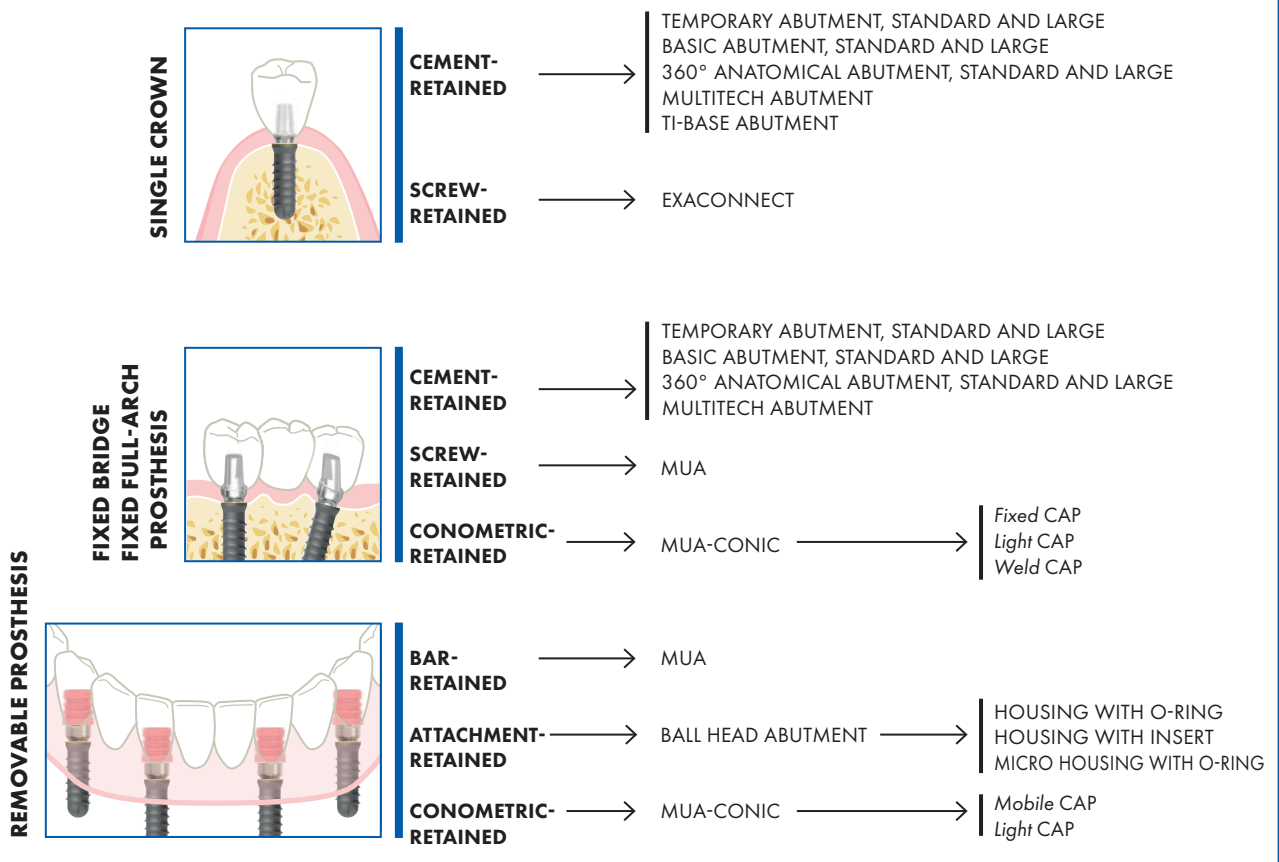

Narrow 2.9

Classix 3.3

Max Stability 3.75

SOFT TISSUE CONDITIONING – STERILE PRODUCTS

UNIVERSAL

HEALING CAPS



Standard

- GH 1,5
- GH 3
- GH 5
- GH 7



Large

- GH 3
- GH 5
- GH 7

page 37

FOR SCREW-RETAINED PROSTHESIS ONLY

EXACONNECT PLUS



page 63

- straight
- 7,5° angled
- 15° angled
- 25° angled

- GH: 1,5 - 3 - 5

MUA PLUS



page 71

- straight
- 7,5° angled
- 15° angled
- 25° angled
- 35° angled

- GH: 1,5 - 3 - 5

CEMENT-RETAINED PROSTHESIS

TRANSFERS IMPLANT LEVEL

TRANSFERS



page 55

- Standard short
- Standard long
- Large

SCAN POST AND SCAN BODY



page 56

- Inclined Plane
- Pyramid

ANALOGS IMPLANT LEVEL

ANALOG



page 55

- L 9 mm
- L 13 mm

DIGITAL ANALOG



page 57

SCREW-RETAINED PROSTHESIS

ABUTMENTS

EXACONNECT



page 62

- straight
- 7,5° - 15° - 25° angled
- GH: 1,5 - 3 - 5

MUA



page 70

- straight
- 7,5° - 15° - 25° - 35° angled
- GH: 1,5 - 3 - 5 - 7

HEALING SCREWS ABUTMENT LEVEL

EXACONNECT HEALING SCREW



page 64

MUA HEALING SCREWS



page 72

- Ø 3,8 mm
- Ø 4,5 mm

CONOMETRIC-RETAINED PROSTHESIS

ABUTMENTS

MUA-CONIC



pages 78, 80

- straight
- 7,5° - 15° - 25° - 35° angled
- GH: 1,5 - 3 - 5 - 7

ATTACHMENT-RETAINED PROSTHESIS

ABUTMENTS

BALL HEAD



page 86

- straight
- 15° angled
- GH: 1,5 - 3 - 5





HOUSINGS

WITH O-RING







page 88

ABUTMENTS

TEMPORARY	BASIC	360° ANATOMICAL	MULTITECH	TI-BASE
 <p>page 48</p>	 <p>page 49</p>	 <p>page 51</p>	 <p>page 53</p>	 <p>page 54</p>
<p>Standard and Large</p> <ul style="list-style-type: none"> - straight - 15° angled 	<p>Standard and Large</p> <ul style="list-style-type: none"> - straight - 15° - 25° angled 	<p>Standard and Large</p> <ul style="list-style-type: none"> - straight - 15° - 25° angled - GH: 1 - 2 - 3 - 4 	<ul style="list-style-type: none"> - straight - 15° angled 	<ul style="list-style-type: none"> - straight



TRANSFER ABUTMENT LEVEL

REPOSITIONABLE AND PICK-UP EXACONNECT	LAB AND SCAN TI-BASE AND SCAN BODY
 <p>page 64</p>	 <p>page 65</p> <ul style="list-style-type: none"> - Inclined Plane - Pyramid

REPOSITIONABLE AND PICK-UP MUA	MUA SCAN BODY
 <p>page 72</p>	 <p>page 73</p>

ANALOGS ABUTMENT LEVEL

EXACONNECT ANALOG
 <p>page 64</p>

MUA ANALOG	MUA DIGITAL ANALOG
 <p>page 73</p> <ul style="list-style-type: none"> - straight - 15° angled 	 <p>page 73</p>

PROSTHETIC SCREWS

EXACONNECT CONNECTING SCREWS
 <p>page 66</p>





MUA CONNECTING SCREWS
 <p>page 75</p> <ul style="list-style-type: none"> - low head - high head

COMPONENTS ABUTMENT LEVEL

EXACONNECT ABUTMENT
 <p>pages 65, 66</p> <ul style="list-style-type: none"> - temporary - Ti-Base - burn-out for Ti-Base

MUA CYLINDERS
 <p>pages 74, 75</p> <ul style="list-style-type: none"> - CAD-CAM - for bonding - for welding - high burn-out - standard burn-out

CAPS

Light	Mobile	Fixed	Weld
 <p>- made of PEEK for removable and fixed prosthesis</p>	 <p>- made of PEEK for removable prosthesis</p>	 <p>- made of PEEK for fixed prosthesis</p>	 <p>- made of titanium for welding techniques</p>

pages 81, 82



HOUSINGS

WITH INSERT
 <p>page 87</p> <ul style="list-style-type: none"> - with soft white insert - with medium orange insert - with rigid violet insert

MICRO HOUSING

WITH MICRO O-RING
 <p>page 88</p>

O-RING REFILLS

O-RING	MICRO O-RING
	 <p>page 88</p>

INSERT REFILLS

 <p>page 87</p> <ul style="list-style-type: none"> - soft white - medium orange - rigid violet
--



SOFT TISSUE CONDITIONING – STERILE PRODUCTS

UNIVERSAL

HEALING CAPS



- Standard
- GH 1,5
 - GH 3
 - GH 5
 - GH 7



- Large
- GH 3
 - GH 5
 - GH 7

page 37

FOR SCREW-RETAINED PROSTHESIS ONLY

EXACONNECT PLUS



page 63

- straight
- 7,5° angled
- 15° angled
- 25° angled

- GH: 1,5 - 3 - 5

MUA PLUS



page 71

- straight
- 7,5° angled
- 15° angled
- 25° angled
- 35° angled

- GH: 1,5 - 3 - 5

TRANSFERS IMPLANT LEVEL

TRANSFERS



page 55

- Standard short
- Standard long
- Large

SCAN POST E SCAN BODY



page 56

- Inclined Plane
- Pyramid

ANALOGS IMPLANT LEVEL

ANALOG



page 55

- L 9 mm
- L 13 mm

DIGITAL ANALOG



page 57

CEMENT-RETAINED PROSTHESIS

ABUTMENTS

EXACONNECT



page 62

- straight
- 7,5° - 15° - 25° angled

- GH: 1,5 - 3 - 5

HEALING SCREWS ABUTMENT LEVEL

EXACONNECT HEALING SCREW



page 64

SCREW-RETAINED PROSTHESIS

MUA



page 70

- straight
- 7,5° - 15° - 25° - 35° angled

- GH: 1,5 - 3 - 5 - 7

MUA HEALING SCREWS



page 72

- Ø 4,5 mm
- Ø 5,0 mm

CONOMETRIC-RETAINED PROSTHESIS

ABUTMENTS

MUA-CONIC



pages 78, 80

- straight
- 7,5° - 15° - 25° - 35° angled

- GH: 1,5 - 3 - 5 - 7

ATTACHMENT-RETAINED PROSTHESIS

ABUTMENTS

A TESTA SFERICA



page 86

- straight
- 15° angled

- GH: 1,5 - 3 - 5





HOUSINGS

WITH O-RING







page 88

ABUTMENTS

TEMPORARY	BASIC	360° ANATOMICAL	MULTITECH	TI-BASE
 <p>page 48</p>	 <p>page 49</p>	 <p>page 51</p>	 <p>page 53</p>	 <p>page 54</p>
<ul style="list-style-type: none"> - straight - 15° angled 	<ul style="list-style-type: none"> - straight - 15° - 25° angled 	<ul style="list-style-type: none"> - straight - 15° - 25° angled - GH: 1 - 2 - 3 - 4 	<ul style="list-style-type: none"> - straight - 15° angled 	<ul style="list-style-type: none"> - straight



TRANSFER ABUTMENT LEVEL

REPOSITIONABLE AND PICK-UP EXACONNECT	LAB AND SCAN TI-BASE AND SCAN BODY
 <p>page 64</p>	 <p>page 65</p> <ul style="list-style-type: none"> - Inclined Plane - Pyramid

REPOSITIONABLE AND PICK-UP MUA	MUA SCAN BODY
 <p>page 72</p>	 <p>page 73</p>

ANALOGS ABUTMENT LEVEL

EXACONNECT ANALOG
 <p>page 64</p>

MUA ANALOG	MUA DIGITAL ANALOG
 <p>page 73</p> <ul style="list-style-type: none"> - straight - 15° angled 	 <p>page 73</p>

PROSTHETIC SCREWS

EXACONNECT CONNECTING SCREWS
 <p>page 66</p>





MUA CONNECTING SCREWS
 <p>page 75</p> <ul style="list-style-type: none"> - low head - high head

COMPONENTS ABUTMENT LEVEL

EXACONNECT ABUTMENT
 <p>pages 65, 66</p> <ul style="list-style-type: none"> - temporaneo - Ti-Base - calcinabile per TiBase

MUA CYLINDERS
 <p>pages 74, 75</p> <ul style="list-style-type: none"> - CAD-CAM - for bonding - for welding - high burn-out - standard burn-out

CAPS

Light	Mobile	Fixed	Weld
 <ul style="list-style-type: none"> - made of PEEK for removable and fixed prosthesis 	 <ul style="list-style-type: none"> - made of PEEK for removable prosthesis 	 <ul style="list-style-type: none"> - made of PEEK for fixed prosthesis 	 <p>pages 81, 82</p> <ul style="list-style-type: none"> - made of titanium for welding techniques



HOUSINGS

WITH INSERT
 <p>page 87</p> <ul style="list-style-type: none"> - with soft white insert - with medium orange insert - with rigid violet insert

MICRO HOUSING

WITH MICRO O-RING
 <p>page 88</p>

O-RING REFILLS

O-RING	MICRO O-RING
	 <p>page 88</p>

INSERT REFILLS

 <p>page 87</p> <ul style="list-style-type: none"> - soft white - medium orange - rigid violet
--

IMPLANT SYSTEM

XCN[®]

ABUTMENTS FOR
CEMENT-RETAINED
PROSTHESIS
AND IMPRESSION ACCESSORIES



ABUTMENTS FOR CEMENT-RETAINED PROSTHESIS AND IMPRESSION ACCESSORIES

Ideal for

- single crowns
- partial edentulism (bridges)
- complete edentulism (Full-arch)
- immediate loading

Standard and Large platform

Thanks to Platform Switching, it is possible to choose the most appropriate abutment diameter for the clinical situation.

Healing caps and transfers dedicated to the platform allow for excellent results in soft tissue conditioning and impression taking.

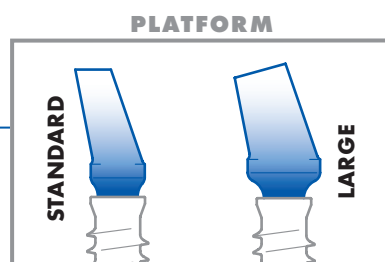

Extra-oral cementation

The XCN® connection system permits procedures that are not possible with screwed connection systems, such as extra-oral cementation, that eliminates the risks associated with excess cement remaining in the periimplant tissues.



Courtesy of Dr. S. Belcastro

Solid abutments, without preparation limit

All XCN® abutments for cement-retained prosthesis are solid, without a screw channel. As a result, the abutments are totally customizable, easy to prepare, more aesthetic and stronger.



MultiTech abutments, simply unique

The absence of a channel for the screw has made it possible to create a bonding base with an extremely thin and at the same time extremely strong bonding portion. The special geometry allows the fabrication of resistant and aesthetically pleasing customised abutments, even in the presence of low gingival thickness, deep mucosal tunnel and high disparallelism, as for example in the case of implants placed in the tuber region.



Courtesy of Dr. L. Palazzo



Anatomical abutments with 360° connection

Ready-to-use abutments that simplify the dental technician's work with a wide range of angulations, pre-shaped shoulders in 4 different heights and the patented XCN® 360° connection.



XCN® Implant Level impression, simple and precise

The XCN® connection considerably simplifies prosthetic procedures, starting with the impression taking. The split hexagon of the transfer is easily connected by friction to the internal hexagon of the implant, the stop indicates that the correct end position has been reached and the impression is taken with a closed tray.

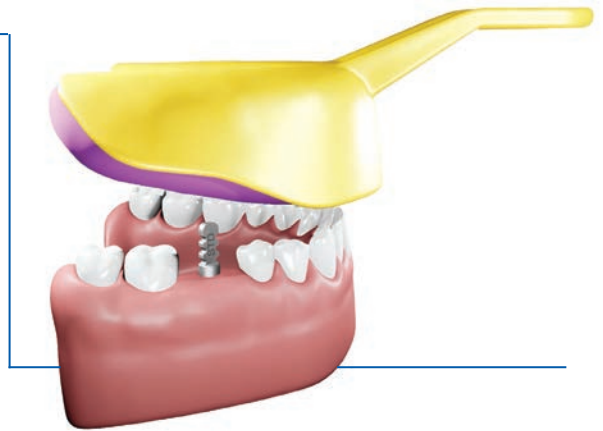

A solution for every need



PROVISIONAL
TEMPORARY ABUTMENTS
Made of PEEK

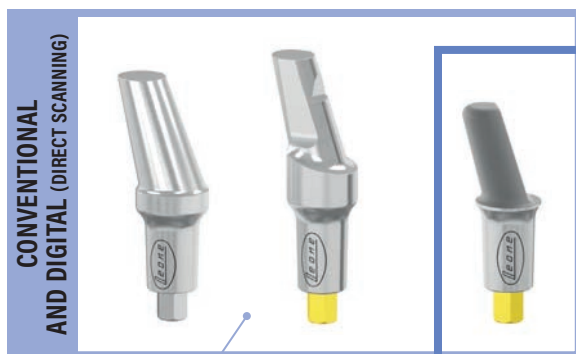

CONVENTIONAL AND DIGITAL (DIRECT SCANNING)
ABUTMENTS: BASIC, 360° ANATOMICAL, MULTITECH
Optimal for traditional techniques and direct scanning

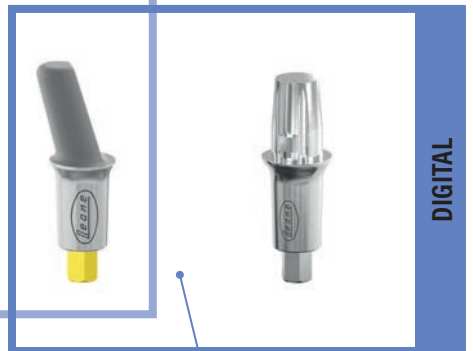

DIGITAL
ABUTMENTS: MULTITECH, TI-BASE
Inserted in the library of the most popular CAD-CAM software

TEMPORARY ABUTMENT STANDARD AND LARGE



Features

- made of PEEK
- for provisional prostheses
- radiolucent
- autoclavable

Pack of 1

Necessary instruments

- selection of the most appropriate temporary abutment with the Abutment Gauges
- **straight abutments:** activation of the connection with the abutment seater with straight or offset titanium tip
- **angled abutments:** activation of the connection with the abutment seater with flat tip
- removal with extraction pliers

	1:1		1:1		
	standard	large	standard	large	
Ø connection (mm)	2,2	2,2	3,0	3,0	
Ø prosthetic platform (mm)	3,3	4,5	4,1	5,5	
REF	straight 15° angled	161-3310-00 161-3310-15	161-4510-00 161-4510-15	161-4110-00 161-4110-15	161-5510-00 161-5510-15

BASIC ABUTMENTS STANDARD AND LARGE



Features

- made of medical grade 5 titanium
- ideal for vertical (feather-edge) preparation technique
- **Standard:** suitable for soft tissues with at least 2 mm thickness
- **Large:** suitable for soft tissues with at least 2.5 mm thickness

Pack of 1

Necessary instruments

- selection of the most appropriate Basic Abutment with the Abutment Gauges
- **straight abutments:** activation of the connection with the abutment seater with straight or offset titanium tip
- **angled abutments:** activation of the connection with the abutment seater with flat tip

	1:1		1:1		
	standard	large	standard	large	
Ø connection (mm)	2,2	2,2	3,0	3,0	
Ø prosthetic platform (mm)	3,3	4,5	4,1	5,5	
REF	straight 15° angled 25° angled	120-3310-33 124-3303-01 124-3303-02	120-3310-45 124-3303-03 124-3303-04	120-4110-41 124-4103-01 124-4103-02	120-4110-55 124-4103-03 124-4103-04

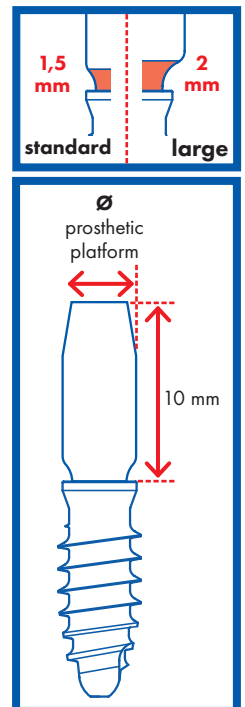

360° ANATOMICAL ABUTMENTS STANDARD AND LARGE



Step

- parallel to the implant axis on all angled abutments, for correct activation of the connection

2 opposite plain faces

- to improve the retention of crowns

Preformed abutment shoulder

- in 4 gingival heights (GH)

XCN® 360° connection

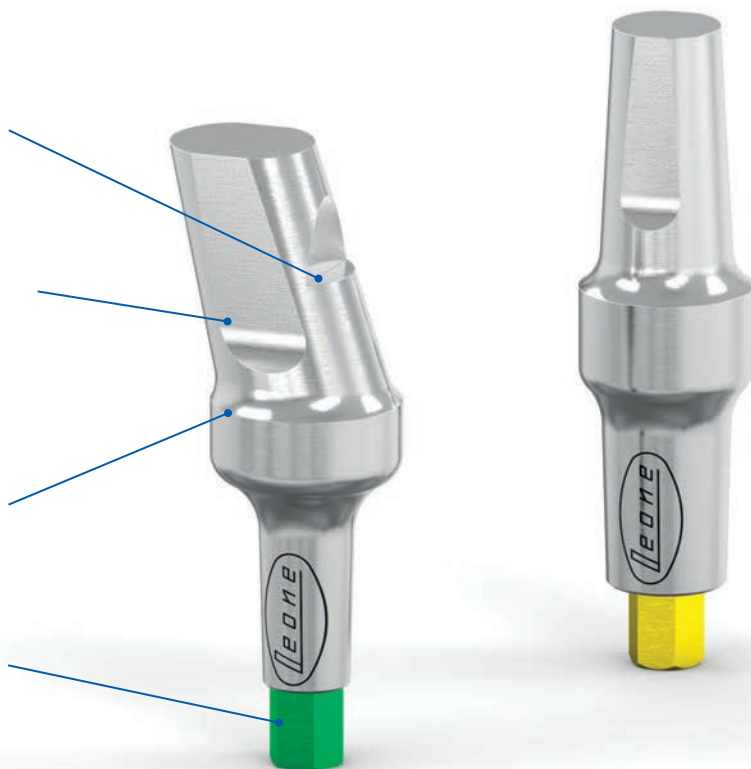

Features

- made of medical grade 5 titanium
- ready to use, no or only limited need of preparation
- autoclavable

Necessary instruments

- selection of the most appropriate 360° abutment with the Abutment Gauges
- **straight abutments:** activation of the connection with the abutment seater with straight or offset titanium tip
- **angled abutments:** activation of the connection with the abutment seater with flat tip

Pack content

- 1 abutment
- 1 hexagon

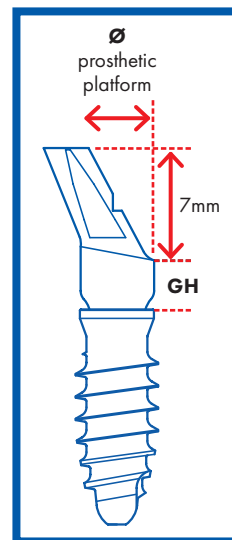

360° Anatomical abutments **standard**

		1:1			
Ø connection (mm)	2,2	2,2	2,2	2,2	
Ø prosthetic platform (mm)	3,3	3,3	3,3	3,3	
GH (mm)	1	2	3	4	
REF	straight	129-3300-03	129-3301-00	129-3302-00	129-3303-00
	15° angled	129-3300-01	129-3301-01	129-3302-01	129-3303-01
	25° angled	129-3300-02	129-3301-02	129-3302-02	129-3303-02

360° Anatomical abutments **large**

		1:1	
Ø connection (mm)	2,2	2,2	
Ø prosthetic platform (mm)	4,5	4,5	
GH (mm)	2	3	
REF	straight	129-4501-00	129-4502-00
	15° angled	129-4501-01	129-4502-01
	25° angled	129-4501-02	129-4502-02

360° Anatomical abutments **standard**

		1:1			
Ø connection (mm)		3,0	3,0	3,0	3,0
Ø prosthetic platform (mm)		4,1	4,1	4,1	4,1
GH (mm)		1	2	3	4
REF	straight	129-4100-03	129-4101-00	129-4102-00	129-4103-00
	15° angled	129-4100-01	129-4101-01	129-4102-01	129-4103-01
	25° angled	129-4100-02	129-4101-02	129-4102-02	129-4103-02

360° Anatomical abutments **large**

		1:1	
Ø connection (mm)		3,0	3,0
Ø prosthetic platform (mm)		5,5	5,5
GH (mm)		2	3
REF	straight	129-5501-00	129-5502-00
	15° angled	129-5501-01	129-5502-01
	25° angled	129-5501-02	129-5502-02

HEXAGONS FOR 360° ABUTMENTS

- made of medical grade 5 titanium
- refill for abutments with XCN® 360° connection
- autoclavable

Pack of 2

for abutments with
Ø connection (mm)

REF

129-3300-00

129-4100-00



2,2



3,0

1:1

MULTITECH ABUTMENTS

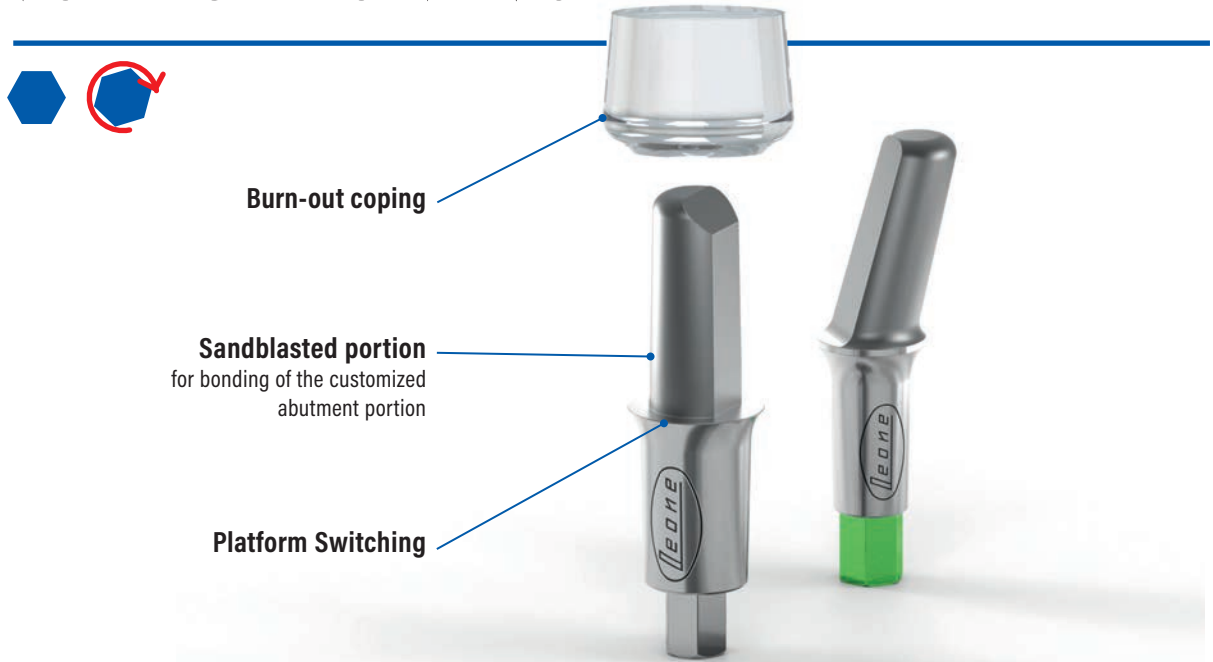

Features

- made of medical grade 5 titanium
- to fabricate a fully patient-customized abutment by creating an abutment portion to be bonded onto MultiTech
- to fabricate a customized abutment portion with CAD-CAM technology or with the traditional method by using the burn-out coping

Pack content: 1 abutment, 1 hexagon (for the angled abutments only), 2 burn-out copings

Hybrid
titanium/zirconia
abutment



Necessary instruments

- selection of the most appropriate MultiTech abutment with the Abutment Gauges
- **straight abutments:** activation of the connection with the abutment seater with straight or offset PEEK tip
- **angled abutments with customized metal or zirconia portion:** activation of the connection with the abutment seater with flat tip

	1:1	1:1
Ø connection (mm)	2,2	3,0
Ø prosthetic platform (mm)	2,9	3,7
REF	121-3306-00 121-3306-15	121-4106-00 121-4106-15

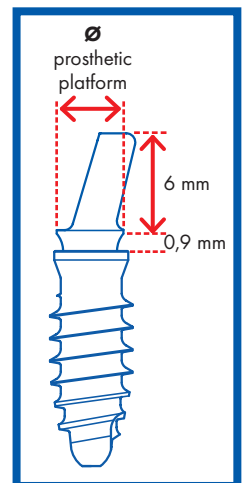

TI-BASE ABUTMENT



Features

- made of medical grade 5 titanium
- to create a monolithic dental crown with CAD-CAM technology
- to fabricate a fully patient-customized abutment by creating an abutment portion with CAD-CAM technology to be bonded onto Ti-Base
- coronal portion suitable for S blocks specific for CAM milling
- autoclavable

Pack of 1



Courtesy of Dr. M. Pisa

Necessary instruments

- **straight ceramic restorations:**
activation of the connection with the abutment seater with straight or offset PEEK tip
- **angled ceramic restorations:**
activation through the hole of the block (with the long bar supplied with the analog package)

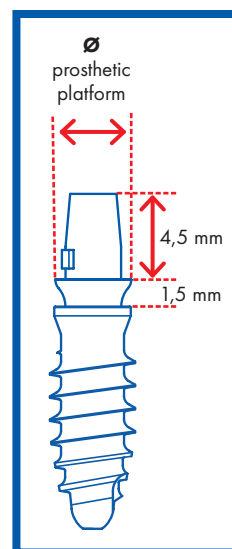
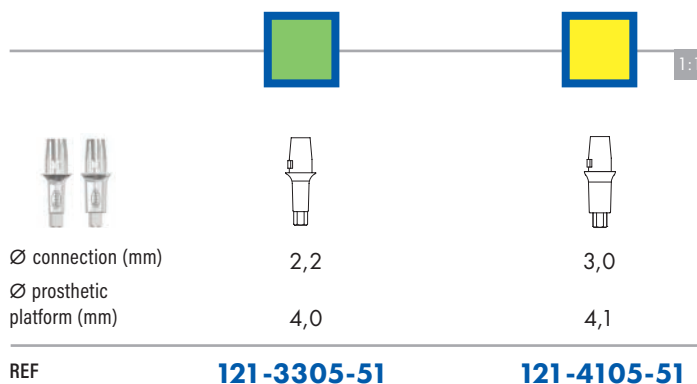











TRANSFERS STANDARD AND LARGE

- made of stainless steel
 - to take an impression at implant level with a closed impression tray
 - colour-coded
 - autoclavable
- Pack of 1**



	standard		large
			
Ø connection (mm)	2,2	2,2	2,2
Ø prosthetic platform (mm)	3,3	3,3	4,5
GH (mm)	5	8	5
REF	141-3305-33	141-3308-33	141-3305-45

	standard		large
			
Ø connection (mm)	3,0	3,0	3,0
Ø prosthetic platform (mm)	4,1	4,1	5,5
GH (mm)	5	8	5
REF	141-4105-41	141-4108-41	141-4105-55

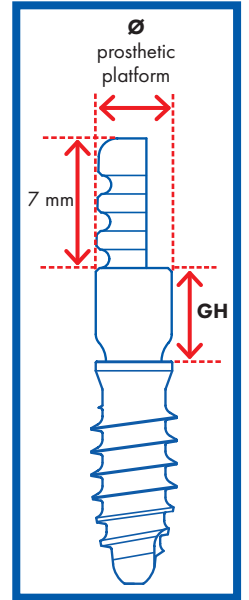

POSITIONER FOR STANDARD TRANSFER

- made of stainless steel
 - to place the transfer into the implant in hard-to-reach areas
 - with a hole for the placement of a safety leash
 - autoclavable
- Pack of 1**

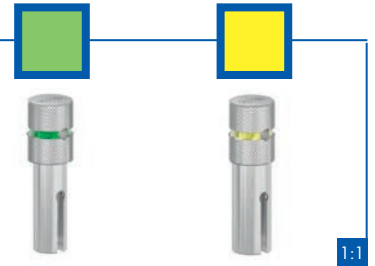

REF **141-0001-33** **141-0001-41**





ANALOGS

- made of stainless steel
- to replicate the position of the implant in the dental cast
- available in two versions: standard and long
- colour-coded

Pack content:

- 1 analog
- 1 pin
- 1 bar for the removal of the abutment



	standard		large	
				
Ø connection (mm)	2,2	2,2	3,0	3,0
REF	L 9 mm	142-3309-00	L 13 mm	142-4109-00
		142-3313-00		142-4113-00

SCAN POST AND SCAN BODIES INCLINED PLANE AND PYRAMID*

- **Scan Post:** made of stainless steel
- **Scan Bodies:** made of plastic material
- to take a digital impression at implant level in the mouth or to digitize the dental cast in the laboratory
- autoclavable

Pack content:

Inclined Plane

- 1 Scan Post
- 3 white Scan Bodies Inclined Plane

Pyramid

- 1 Scan Post
- 3 white Scan Bodies Pyramid
- 3 grey Scan Bodies Pyramid

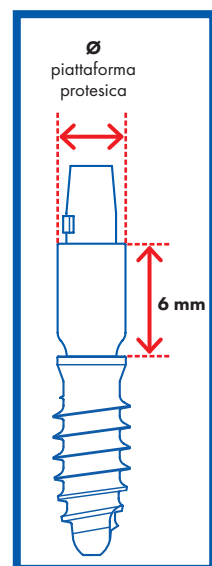
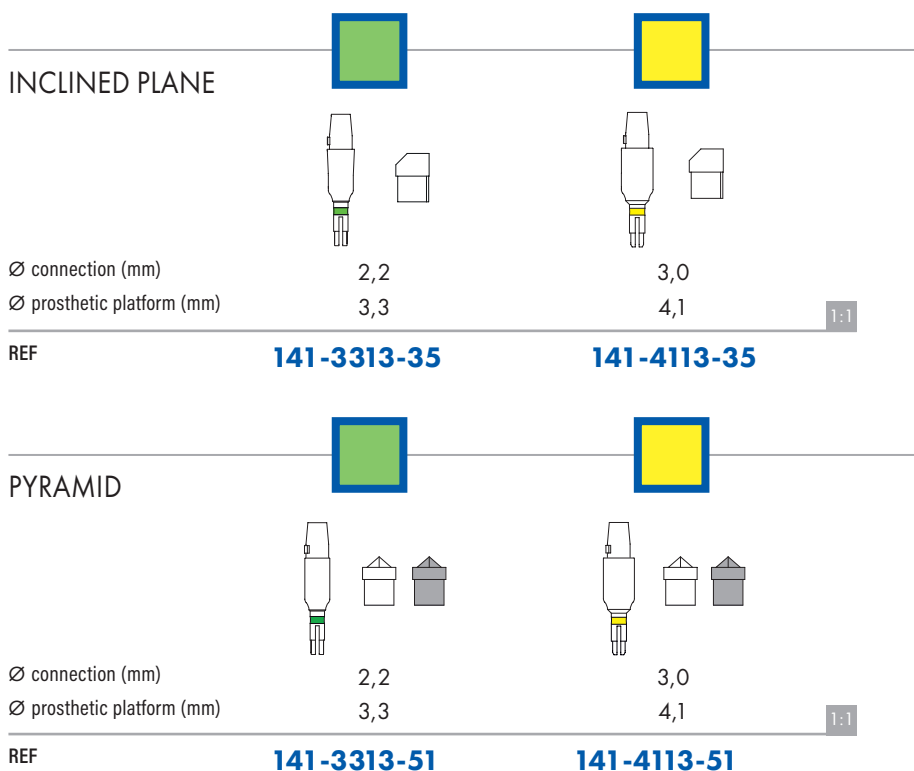

SCAN BODY INCLINED PLANE

- made of plastic material
- for Scan Post and Ti-Base
- autoclavable

Pack of 5 (white)



REF **141-0000-35**

SCAN BODIES PYRAMID

- made of plastic material
- for Scan Post and Ti-Base
- autoclavable

Pack of 10 (5 white and 5 grey)



REF **141-0000-51**

SCAN POST POSITIONER

- made of stainless steel
- to place the Scan Post into the implant
- with a hole for the placement of a safety leash
- autoclavable

Pack of 1



1:1

REF **141-0001-51**

DIGITAL ANALOGS *

- made of stainless steel
- to be positioned inside a rapid prototyping dental cast originated from an intraoral digital impression
- colour-coded

Pack content:

- 1 analog
- 1 positioner for analogs
- 2 pins for the stabilization within the cast
- 1 bar for the removal of the abutment

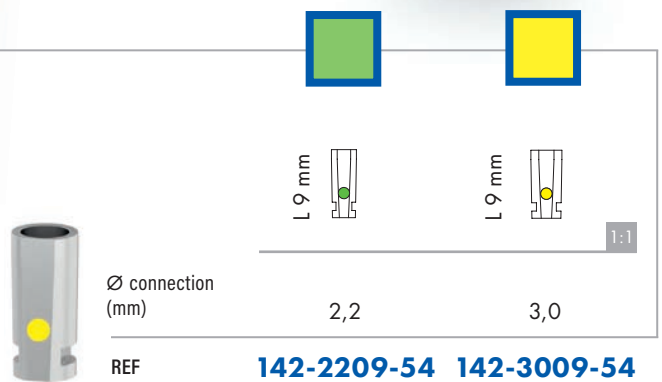
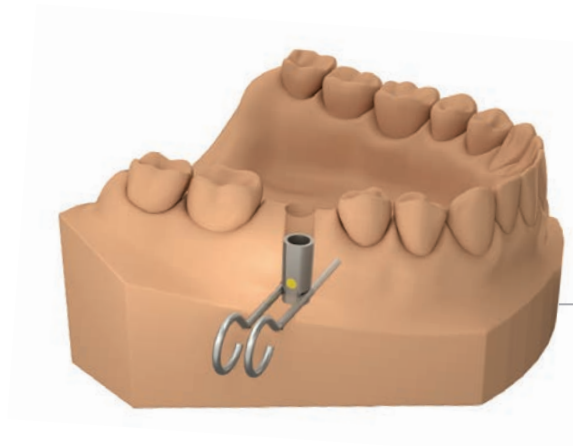

*On Leone web site it is possible to download the libraries of the CAD-CAM software in which Leone system is present:
www.leone.it/english/implantology

IMPLANT SYSTEM

XCN[®]

EXACONNECT FOR
SINGLE-UNIT
SCREW-RETAINED
PROSTHESIS
AND ACCESSORIES

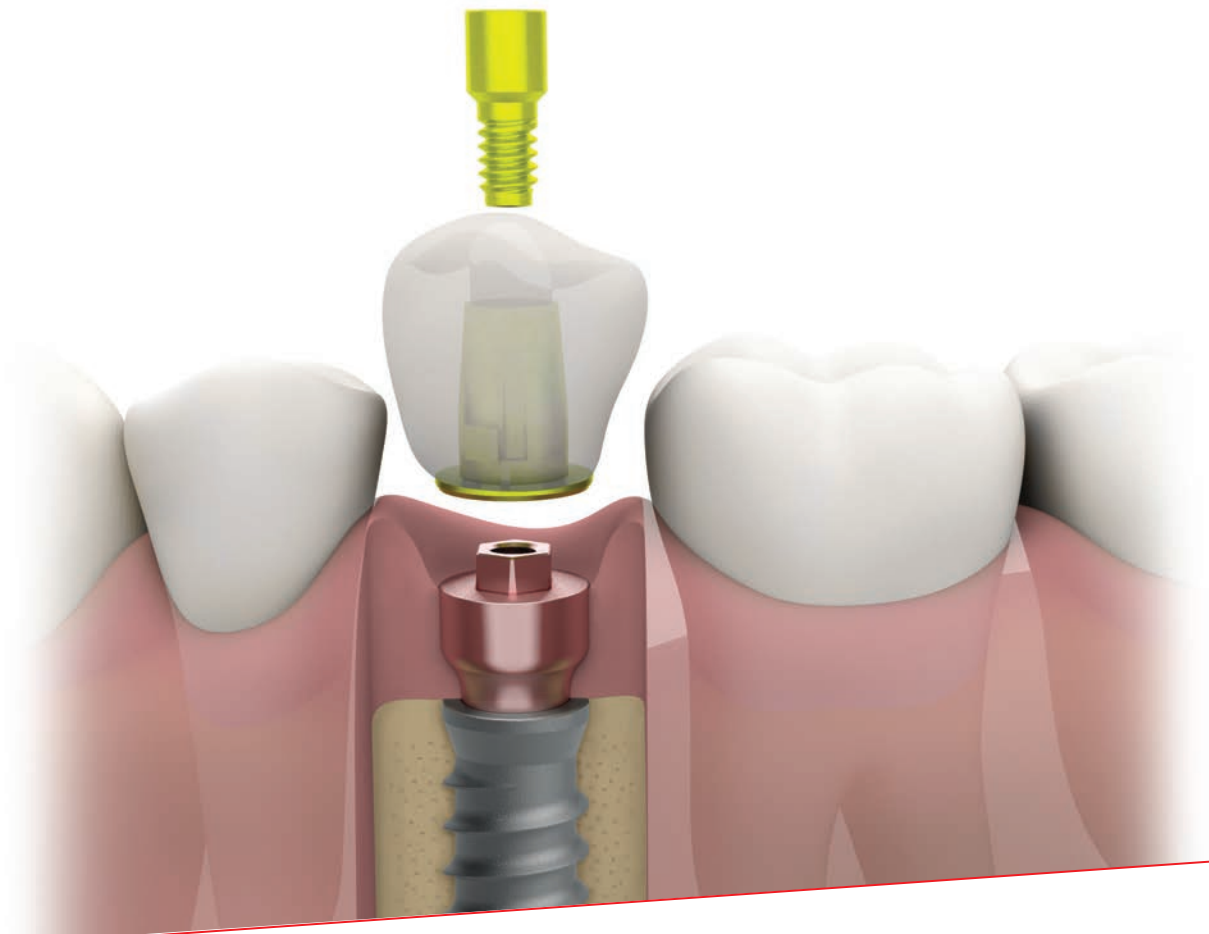

EXACONNECT

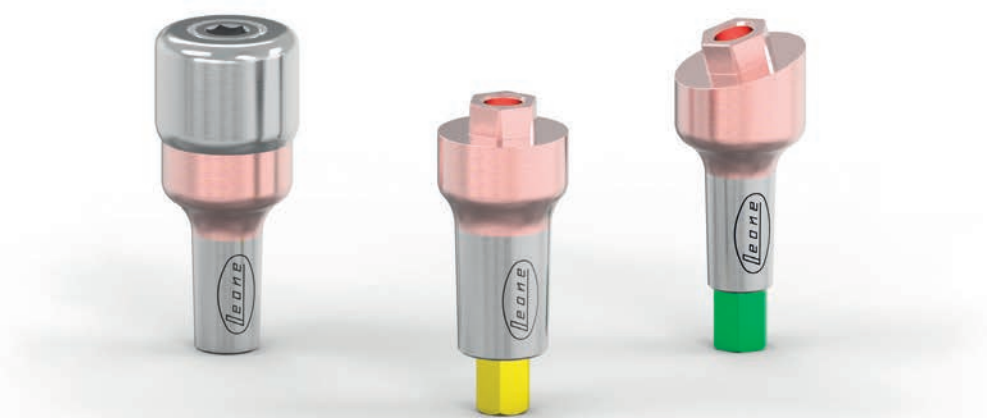

Ideal for

- single screw-retained crown
- deep mucosal tunnel
- transgingival healing (with the corresponding healing screw)
- immediate loading

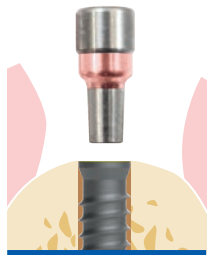

Placement of XCN® implant
and ExaConnect with
healing screw

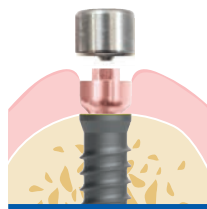

Removal of the healing
screw

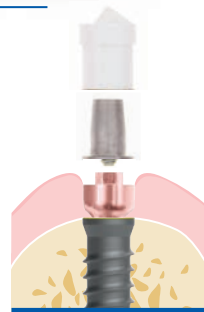

Digital impression
taking on ExaConnect

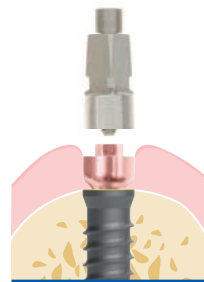

Conventional impression
taking on ExaConnect

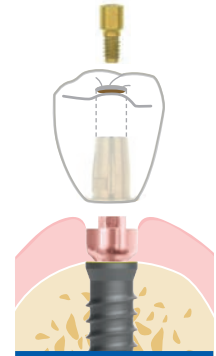

Delivery of the
screw-retained crown

Features

- made of medical grade 5 titanium
- top with external hexagon *Perfect Fit* to reduce abutment screw loosening
- pink anodized
- **ExaConnect**: autoclavable
delivered mounted on a multifunctional screw for easy positioning and orientation
- **ExaConnect Plus**: sterile
delivered mounted on a carrier for easy positioning and orientation

One Abutment-One Time Protocol

A minimally invasive approach in which ExaConnect is inserted immediately after implant placement and is not removed again. Impression taking and fabrication of the crown are done on the ExaConnect safeguarding the tissues during the healing and prosthetic process.

Angled Ti-Base

ExaConnect is ideal for a fully digital workflow as it becomes a Ti-Base abutment with various angulations and various gingival heights.

Prosthetic simplicity

ExaConnect facilitates the prosthetic procedure since it shifts the prosthetic platform from *Bone Level to Tissue Level*, with high flexibility of heights and angulations; a big advantage especially in case of deep mucosal tunnel.

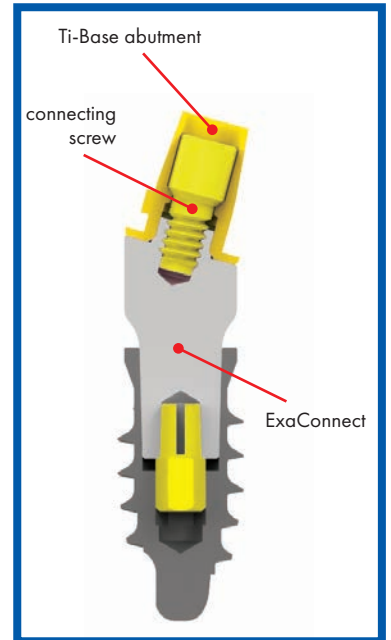

EXACONNECT PLUS - sterile

The ExaConnect Plus is designed for insertion immediately after implant placement. It is delivered mounted on a carrier that facilitates its placement and orientation in the implant. The connector has no index (hexagon) and thus can rotate freely.

The connector has no index (hexagon) and thus can rotate freely. The pre-mounted healing screw allows soft tissue conditioning with the angulation of the selected connector enhancing natural aesthetics. Aesthetics is further improved by the anodization of the ExaConnect.

Thanks to the self-locking Morse taper connection between ExaConnect and the implant, the body recognizes the two elements as one single element becoming the **equivalent of a transmucosal implant**.

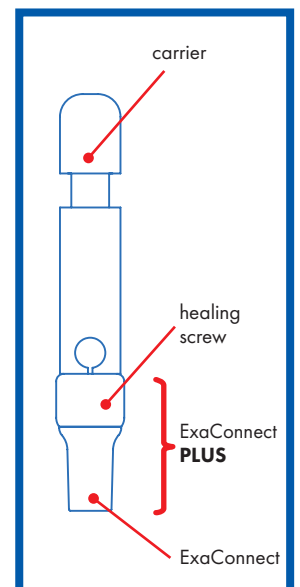

EXACONNECT



Necessary instruments

- selection of the most appropriate ExaConnect with the Abutment Gauges
- activation of the connection with the abutment seater with straight or offset PEEK tip
- in case of > 1 mm subcrestal placement of a green connection implant use the Ø 4,5 mm Bone Profiler

Package

- 1 ExaConnect mounted on multifunctional screw
- 1 hexagon

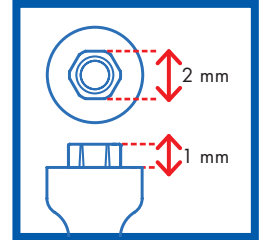

ExaConnect

1:1

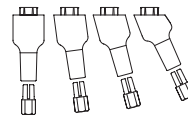
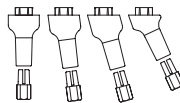
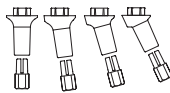

Ø connection (mm)
GH (mm)

2,2
1,5

2,2
3

2,2
5

REF	straight	126-2201-01	126-2203-01	126-2205-01
	7,5° angled	126-2201-07	126-2203-07	126-2205-07
	15° angled	126-2201-15	126-2203-15	126-2205-15
	25° angled	126-2201-25	126-2203-25	126-2205-25

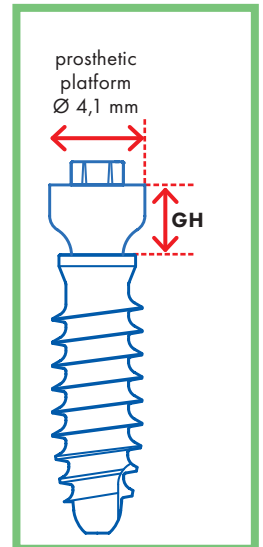

ExaConnect

1:1

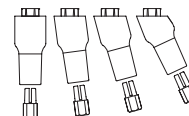
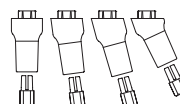
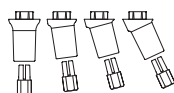

Ø connection (mm)
GH (mm)

3,0
1,5

3,0
3

3,0
5

REF	straight	126-3001-01	126-3003-01	126-3005-01
	7,5° angled	126-3001-07	126-3003-07	126-3005-07
	15° angled	126-3001-15	126-3003-15	126-3005-15
	25° angled	126-3001-25	126-3003-25	126-3005-25

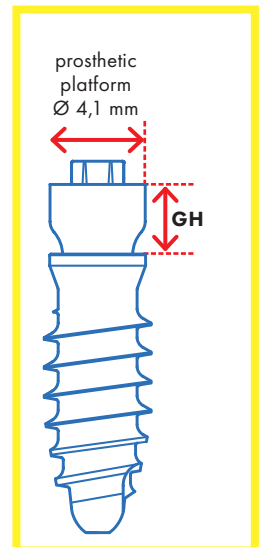

EXACONNECT PLUS



Necessary instruments

- selection of the most appropriate ExaConnect Plus with the Abutment Gauges
- activation of the connection with the abutment seater with straight or offset titanium tip

Sterile package

- 1 ExaConnect with healing screw mounted on carrier



ExaConnect Plus

1:1

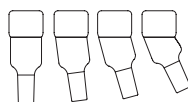
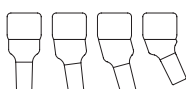

Ø connection (mm)
GH (mm)

2,2
1,5

2,2
3

2,2
5

REF straight
75° angled
15° angled
new 25° angled

126-2221-01
126-2221-07
126-2221-15
126-2221-25

126-2223-01
126-2223-07
126-2223-15
126-2223-25

126-2225-01
126-2225-07
126-2225-15
126-2225-25

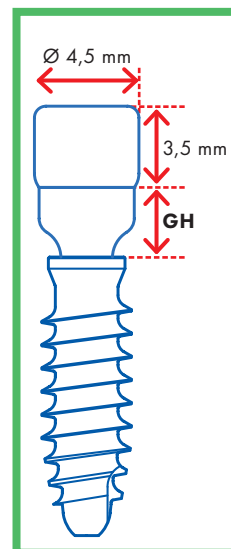

ExaConnect Plus

1:1

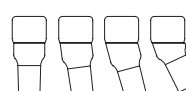

Ø connection (mm)
GH (mm)

3,0
1,5

3,0
3

3,0
5

REF straight
75° angled
15° angled
new 25° angled

126-3021-01
126-3021-07
126-3021-15
126-3021-25

126-3023-01
126-3023-07
126-3023-15
126-3023-25

126-3025-01
126-3025-07
126-3025-15
126-3025-25

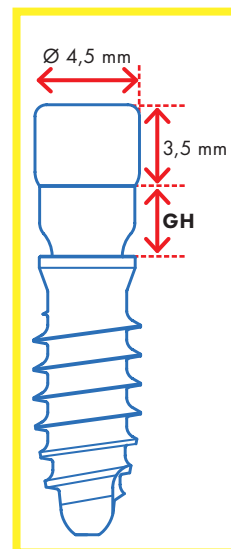

exaconnect for single-unit screw-retained prosthesis and accessories



HEALING SCREW FOR EXACONNECT

- made of medical grade 5 titanium
- for soft tissue conditioning with the ExaConnect
- autoclavable

Pack of 1

Necessary instruments:

- screw adapter with the prosthetic hand screwdriver

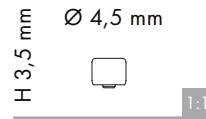

REF **126-2230-00**

REPOSITIONABLE TRANSFER FOR EXACONNECT

- made of stainless steel
- to take an impression of the ExaConnect connected to the implant
- for closed tray technique
- autoclavable

Pack content:

- 1 repositionable transfer
- 1 screw for repositionable transfer

Necessary instruments:

- screw adapter with the prosthetic hand screwdriver

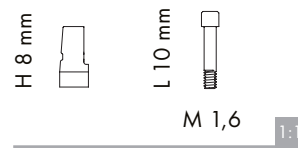

REF **144-2610-00**

TRANSFER PICK-UP FOR EXACONNECT

- made of stainless steel
- to take an impression of the ExaConnect connected to the implant
- for open tray technique
- autoclavable

Pack content:

- 1 Pick-Up transfer
- 1 Pick-Up screw

Necessary instruments:

- screw adapter with the prosthetic hand screwdriver

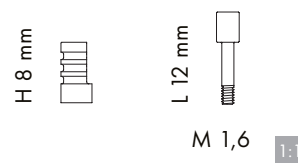

REF **144-2608-01**

EXACONNECT ANALOG

- made of stainless steel
- to replicate the position of the ExaConnect in the dental cast

Pack of 1

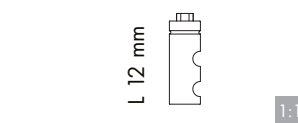

REF **146-2612-00**

TI-BASE ABUTMENT FOR EXACONNECT

- made of medical grade 2 titanium
- for definitive restoration
- for the fabrication of a screw-retained crown with CAD-CAM technology or traditional method
- yellow anodized to camouflage the metal under translucent ceramic crowns
- autoclavable

Pack content:

- 1 yellow anodized abutment
- 1 yellow anodized connecting screw

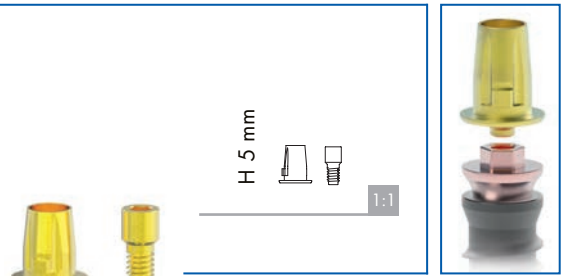

REF **121-2605-51**

LAB AND SCAN TI-BASE PER EXACONNECT

- made of stainless steel
- for digital impression taking and try-in on ExaConnect and ExaConnect analog
- not suitable for restoration
- autoclavable

Pack content:

- 1 Lab and Scan Ti-Base
- 1 connecting screw

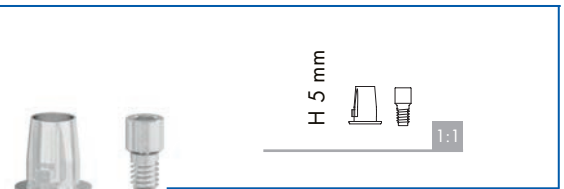

REF **141-2605-51**

SCAN BODY INCLINED PLANE

- made of plastic material
- to take a digital impression of the ExaConnect in the mouth or to digitize the dental cast in the laboratory
- for use with Lab and Scan Ti-Base for ExaConnect
- autoclavable

Pack of 5, white

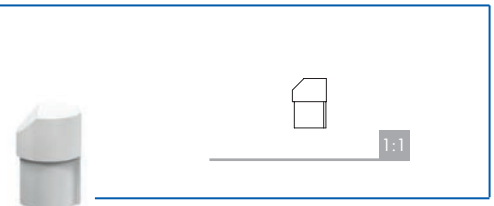

REF **141-0000-35**

SCAN BODY PYRAMID

- made of plastic material
- to take a digital impression of the ExaConnect in the mouth or to digitize the dental cast in the laboratory
- for use with Lab and Scan Ti-Base for ExaConnect
- autoclavable

Pack of 10 (5 white and 5 grey)

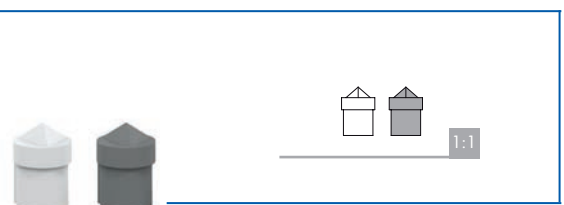

REF **141-0000-51**

exaconnect for single-unit screw-retained prosthesis and accessories



BURN-OUT COPING FOR TI-BASE FOR EXACONNECT

- made of burn-out plastic material
- to fabricate a screw-retained crown with conventional method to be bonded onto the Ti-Base abutment
- for use with Lab and Scan Ti-Base for ExaConnect

Pack of 4

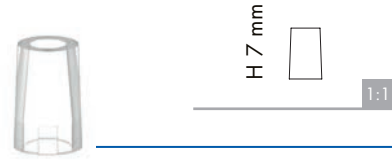

REF **121-0207-26**

TEMPORARY ABUTMENT FOR EXACONNECT

- made of PEEK
- to fabricate a provisional screw-retained crown
- radiolucent
- autoclavable

Pack content:

- 1 abutment
- 1 yellow anodized connecting screw

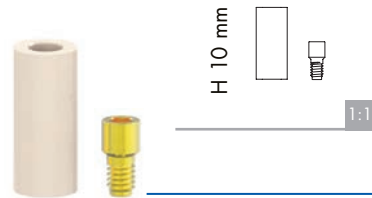

REF **161-2610-00**



MULTIFUNCTIONAL SCREW FOR EXACONNECT

- made of medical grade 5 titanium
- to facilitate orientation and parallelization of the ExaConnect
- to create an adequate sized channel for the connecting screw when modelling the framework in the laboratory
- yellow anodized
- autoclavable

Pack of 2

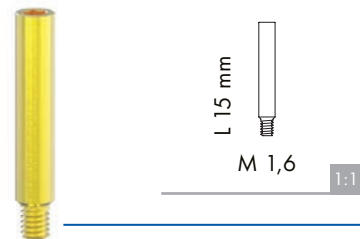

REF **126-0215-06**

CONNECTING SCREW FOR EXACONNECT

- made of medical grade 5 titanium
- to fix the crown to the ExaConnect
- yellow anodized
- autoclavable

Pack of 1

Necessary instruments:

- screw adapter, short or long, with prosthetic hand screwdriver or prosthetic torque wrench
- alternatively handpiece screwdriver



REF **126-0201-00**

IMPLANT SYSTEM

XCN[®]

MUA FOR
MULTI-UNIT
SCREW-RETAINED
PROSTHESIS
AND ACCESSORIES



MUA (Multi-Unit Abutment)

Ideal for

- partial edentulism (bridges)
- complete edentulism (full-arch and bar-retained overdenture)
- immediate loading (All-on-four)
- transgingival healing (with the corresponding healing screw)



Caratteristiche

- made of medical grade 5 titanium
- tapered top for divergence compensation
- **MUA:** autoclavable
delivered mounted on a multifunctional screw for easy positioning and orientation
- **MUA Plus:** sterile
delivered mounted on a carrier for easy positioning and orientation

Broad abutment assortment

The Leone MUA assortment is the broadest on the market with angulations of: 0°, 7.5°, 15°, 25° and 35° and various gingival heights.

Full range also available for small diameter implants.

Prosthetic versatility

The MUA has a range of accessories for various fabrication techniques of screw-retained prosthesis:

- **CAD-CAM interfaces** available in the most popular software like 3Shape Dental System, Exocad DentalCAD, DWOS Dental Wings and EGS Dental Cad* for digital fabrication of screw-retained bars and bridges;
- **titanium cylinders**, with retention grooves and two opposite plain faces for bonding techniques;
- **titanium cylinders with increased wall thickness** with smooth surface and specific titanium wires ideal for welding techniques
- **burn-out cylinders**, standard and high for casting techniques.

*3Shape Dental System is a registered trademark of 3Shape, Exocad is a registered trademark of Exocad GmbH, DWOS and Dental Wings are registered trademarks of Dental Wings, EGS is a registered trademark of EGS s.r.l.

Divergence compensation made easy

Ideal for compensating any kind of divergences of up to 50°, thanks to various angulations and the tapered top.

The XCN 360° connections allows for free positioning of the screw access channel, adapting to any clinical situation. The permanent connection of the 360° hexagon in the selected position guides the clinician in the accurate positioning in the mouth.

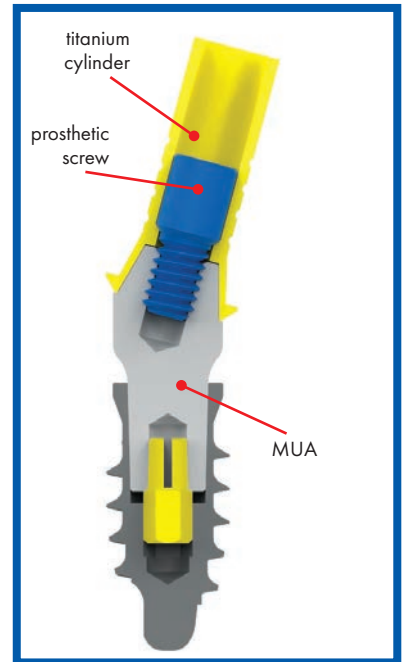
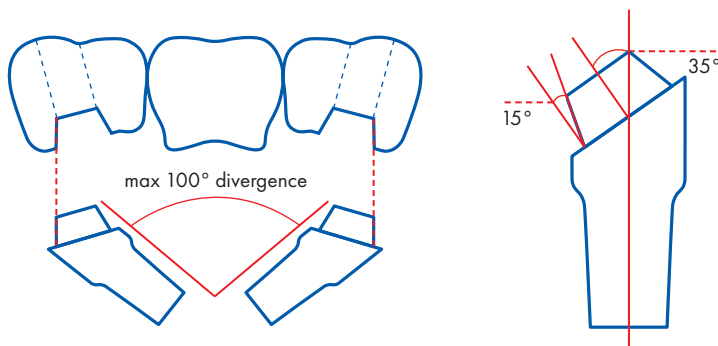

Quick and reliable procedure

With the Leone system there is only one screw to deal with as the connection between abutment and implant is accomplished with the screwless self-locking Morse taper connection. This feature increases the speed of procedures, particularly important in the case of immediate loading.

The prosthetic screw is extremely strong with a diameter of 2 mm (M2).

MUA PLUS - sterile

The MUA Plus is designed for insertion immediately after implant placement. It is delivered mounted on a carrier that facilitates its positioning and orientation in the implant. The abutment has no index (hexagon) and can rotate freely. The immediate retention of the Morse taper avoids any unwanted displacement of the abutment prior to definitive fixing in the implant.

The system includes specific accessories designed for the passive seating of structures during immediate loading procedures, such as titanium cylinders and specific multifunctional screws (ideal for intraoral bonding techniques) or titanium cylinders with increased wall thickness and titanium wires for intraoral welding techniques.

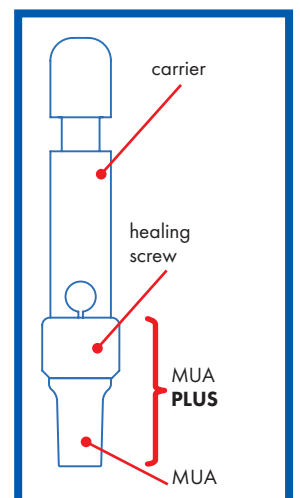

MUA



Necessary instruments

- selection of the most appropriate MUA with the Abutment Gauges
- activation of the connection with the abutment seater with straight or offset PEEK tip

Package

- 1 abutment mounted on multifunctional screw
- 1 hexagon (for the angled abutments only)



	MUA 1:1			
Ø connection (mm)	2,2	2,2	2,2	2,2
Ø prosthetic platform (mm)	3,3	3,3	3,3	3,3
GH (mm)	1,5	3	5	7
straight	126-3311-01	126-3313-01	126-3315-01	126-3317-01
75° angled	126-3311-07	126-3313-07	126-3315-07	
REF 15° angled	126-3311-15	126-3313-15	126-3315-15	
25° angled	126-3311-25	126-3313-25	126-3315-25	
35° angled		126-3313-35	126-3315-35	

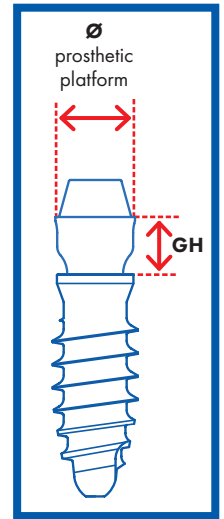
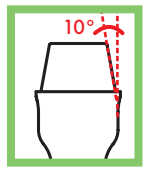

	MUA 1:1			
Ø connection (mm)	3,0	3,0	3,0	3,0
Ø prosthetic platform (mm)	4,1	4,1	4,1	4,1
GH (mm)	1,5	3	5	7
straight	126-4111-01	126-4113-01	126-4115-01	126-4117-01
75° angled	126-4111-07	126-4113-07	126-4115-07	
REF 15° angled	126-4111-15	126-4113-15	126-4115-15	
25° angled	126-4111-25	126-4113-25	126-4115-25	
35° angled		126-4113-35	126-4115-35	

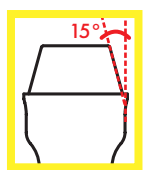

MUA PLUS



Necessary instruments

- selection of the most appropriate MUA Plus with the Abutment Gauges
- activation of the connection with the abutment seater with straight or offset titanium tip

Sterile package

- 1 abutment with healing screw mounted on carrier



MUA Plus

1:1

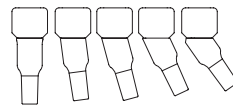
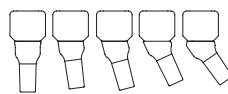
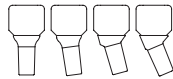

Ø connection (mm)
Ø prosthetic platform (mm)
GH (mm)

2,2
3,3
1,5

2,2
3,3
3

2,2
3,3
5

straight	126-3321-01	126-3323-01	126-3325-01
75° angled	126-3321-07	126-3323-07	126-3325-07
REF 15° angled	126-3321-15	126-3323-15	126-3325-15
25° angled	126-3321-25	126-3323-25	126-3325-25
35° angled		126-3323-35	126-3325-35

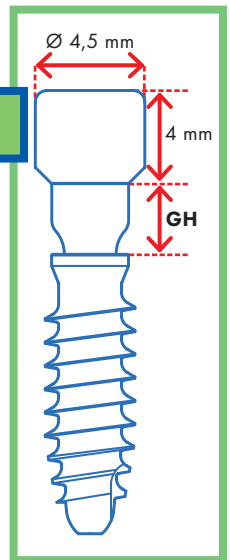

MUA Plus

1:1

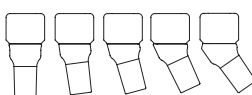

Ø connection (mm)
Ø prosthetic platform (mm)
GH (mm)

3,0
4,1
1,5

3,0
4,1
3

3,0
4,1
5

straight	126-4121-01	126-4123-01	126-4125-01
75° angled	126-4121-07	126-4123-07	126-4125-07
REF 15° angled	126-4121-15	126-4123-15	126-4125-15
25° angled	126-4121-25	126-4123-25	126-4125-25
35° angled		126-4123-35	126-4125-35

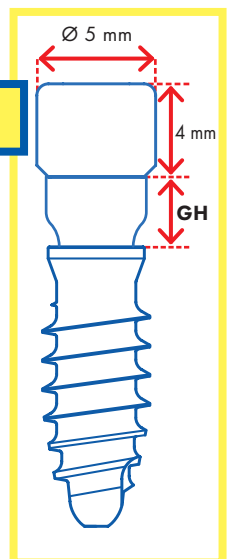

HEALING SCREWS

FOR MUA

- made of medical grade 5 titanium
- for soft tissue conditioning with MUA
- colour-coded
- autoclavable

Pack of 1

Necessary instruments:

screw adapter with the prosthetic hand screwdriver

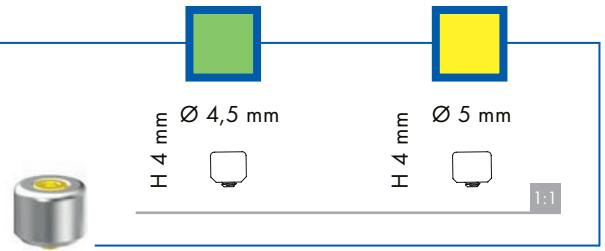

REF **126-3300-00**

126-4100-00

SLIM HEALING SCREWS

FOR MUA

- made of medical grade 5 titanium
- for soft tissue conditioning with MUA
- colour-coded
- autoclavable

Pack of 1

Necessary instruments:

screw adapter with the prosthetic hand screwdriver

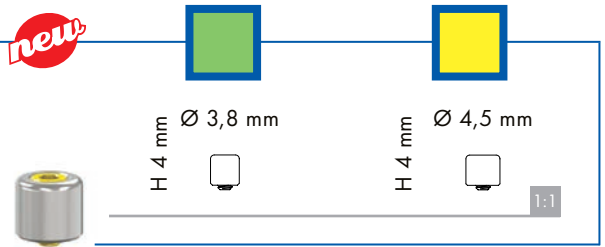

REF **126-3300-38**

126-4100-45

REPOSITIONABLE TRANSFER

FOR MUA

- made of stainless steel
- to take an impression of the MUA connected to the implant
- for closed tray technique
- colour-coded
- autoclavable

Pack of 1

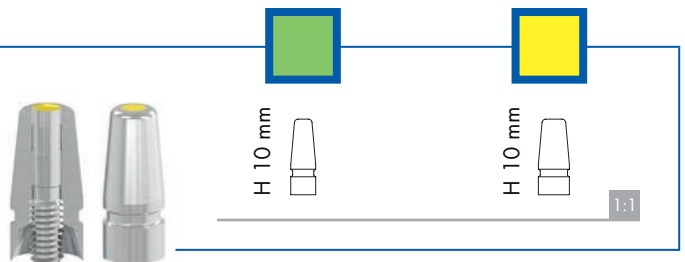

REF **144-3310-00**

144-4110-00

TRANSFER PICK-UP

FOR MUA

- made of stainless steel
- to take an impression of the MUA connected to the implant
- for open tray technique
- colour-coded
- autoclavable

Pack content:

1 Pick-Up transfer

1 Pick-Up screw

Necessary instruments:

screw adapter with the prosthetic hand screwdriver

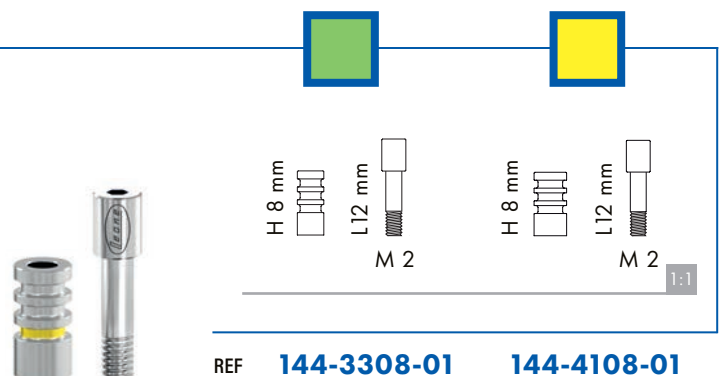

REF **144-3308-01**

144-4108-01

MUA ANALOGS

- made of stainless steel
- to replicate the position of the MUA in the dental cast
- colour-coded

Pack of 1

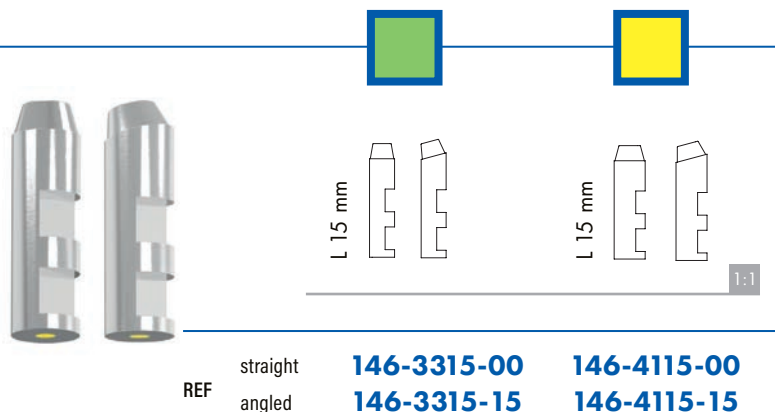

SCAN BODY* FOR MUA

- made of PEEK
- to take a digital impression of the MUA in the mouth or to digitize the dental cast in the laboratory
- autoclavable

Pack of 5

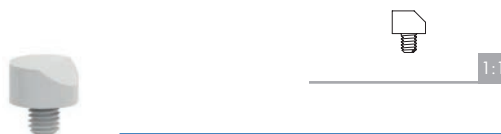

REF **141-0026-35**

POSITIONER FOR SCAN BODY FOR MUA

- made of stainless steel
- to position, screw and unscrew the Scan Body on the MUAs
- with a hole for the placement of a safety leash
- autoclavable

Pack of 1

new

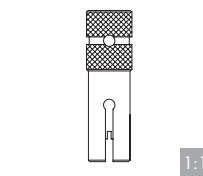

REF **141-0001-35**

DIGITAL ANALOGS* FOR MUA

- made of stainless steel
- to be positioned inside a rapid prototyping dental cast originated from an intraoral digital impression
- colour-coded

Pack content:

- 1 analog
- 1 multifunctional screw for the positioning in the dental cast
- 2 pins for the stabilization within the cast

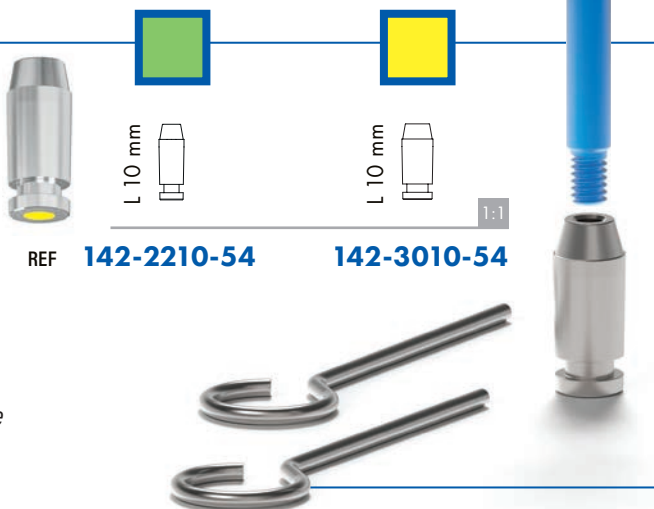

*On Leone web site it is possible to download the libraries of the CAD-CAM software in which Leone system is present:
www.leone.it/english/implantology.

CAD-CAM INTERFACES* FOR MUA

- made of medical grade 5 titanium
- to fix a CAD-CAM fabricated prosthesis to the MUA in case of bonding techniques (e.g. PEEK or zirconia structures)
- colour-coded
- autoclavable

Pack content:

- 2 CAD-CAM interfaces
- 2 low head connecting screws, blue anodized

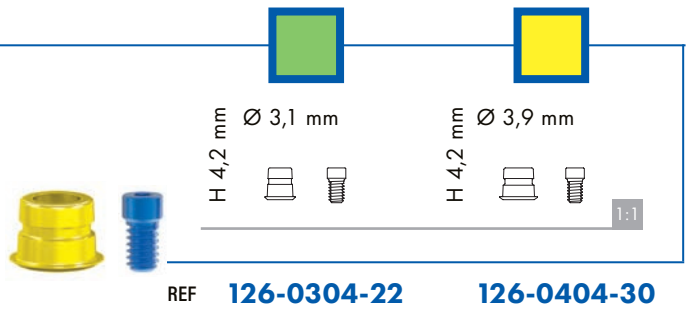

BONDING CYLINDERS FOR MUA

- made of medical grade 5 titanium
- to fix the prosthesis to the MUA
- supplied with cylindrical burn-out coping for bonding techniques
- 0,4 mm wall thickness
- colour-coded
- autoclavable

Pack content:

- 2 cylinders
- 2 burn-out copings for bonding cylinders
- 2 low head connecting screws, blue anodized
- 2 high head connecting screws, blue anodized

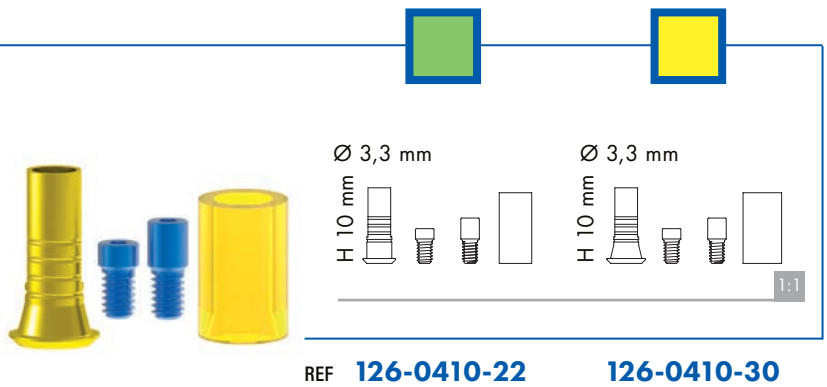

STANDARD BURN-OUT CYLINDERS FOR MUA

- made of burn-out plastic material
- colour-coded

Pack content:

- 4 cylinders
- 4 low head connecting screws, blue anodized

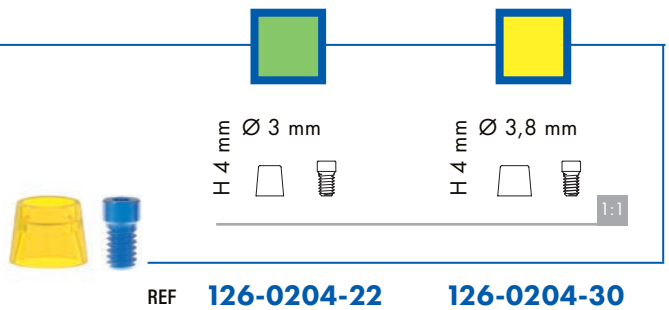

HIGH BURN-OUT CYLINDERS FOR MUA

- made of burn-out plastic material
- colour-coded

Pack content:

- 4 cylinders
- 4 high head connecting screws, blue anodized

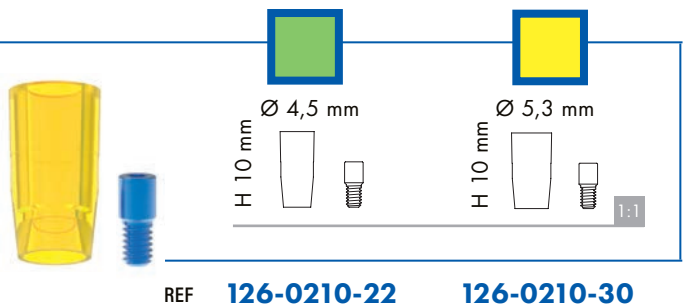

*On Leone web site it is possible to download the libraries of the CAD-CAM software in which Leone system is present:
www.leone.it/english/implantology.

WELDING CYLINDERS FOR MUA

- made of medical grade 5 titanium
- to fix the prosthesis to the MUA
- wall thickness 0.8 mm
- colour-coded
- autoclavable

Pack content:

- 2 cylinders
- 2 low head connecting screws, blue anodized
- 2 high head connecting screws, blue anodized

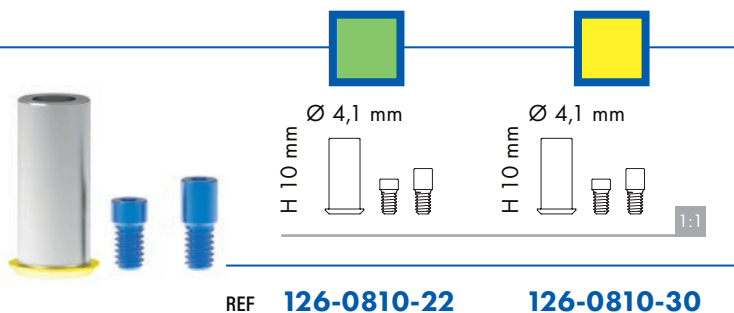

REF **126-0810-22**

126-0810-30

TITANIUM WIRES FOR WELDING

- made of medical grade 2 titanium
- for intra or extra-oral welding techniques
- Ø 1,5 mm: for distances among abutments ≤ 8 mm
- Ø 2 mm: for distances among abutments > 8 mm
- autoclavable

Pack of 5



REF **126-1515-00**

126-2015-00

MULTIFUNCTIONAL SCREW

- made of medical grade 5 titanium
- to position the MUA onto the implant
- to facilitate orientation and parallelization of the abutments
- to close the channels of the titanium cylinders during the fixation of the prosthesis
- to create an adequate sized channel for the connecting screw when modelling the framework in the laboratory
- blue anodized
- autoclavable

Pack of 2

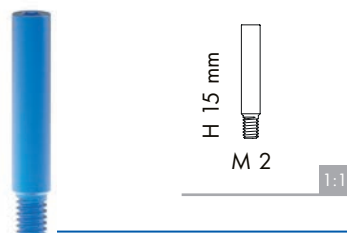

REF **126-0115-06**

CONNECTING SCREWS FOR MUA

- made of medical grade 5 titanium
- to fix the prosthesis to the MUA
- blue anodized
- autoclavable

Pack of 1

Necessary instruments:

- screw adapter, short or long, with prosthetic hand screwdriver or prosthetic torque wrench
- alternatively handpiece screwdriver

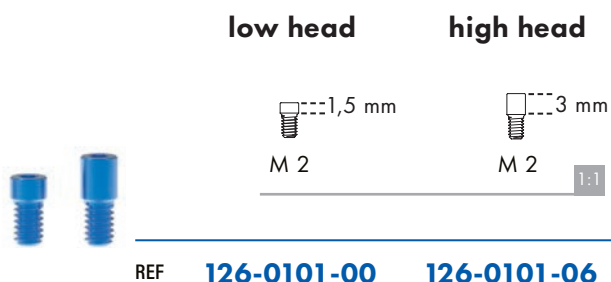

REF **126-0101-00**

126-0101-06

NOTE:

- Both connecting screws and MUA cylinders have been optimized compared to versions present in the previous catalogues.
- All current accessories **are compatible** with the previous abutments for screw-retained prosthesis.
- The current **blue anodized** connecting screws are **NOT compatible** with the titanium and burn-out copings of Leone Catalogue 2015 and previous.
- The **non-anodized** connecting screws of Leone Catalogue 2015 and previous are **NOT compatible** with the current MUA cylinders.
- For previously restored cases the connecting screws and the titanium copings listed in the Leone Catalogue 2015 and previous remain available.



IMPLANT SYSTEM

XCN[®]

CONOMETRIC-RETAINED
PROSTHESIS
AND ACCESSORIES



XCN[®] CONOMETRIC-RETAINED PROSTHESIS easy, precise and safe

By screwing the Conic Adapter onto the MUA, the abutment gets a tapered top with a half-angle of 5° allowing for prosthesis retention by preformed caps that feature an internal connection of the same taper angle.



Ideal for

- partial edentulism (bridges in canine, premolar and molar area)
- complete edentulism (fixed and removable prostheses)
- immediate loading

Advantages

A cement-free prosthesis, as cement residues are removed extraorally, and without connection screws and related access channels. Thanks to the conical friction, the prosthesis has high stability, while allowing easy removal for periodic check-ups and oral hygiene. Innovative Titanium-PEEK interface offers an excellent seal for improved periimplant soft tissue health.

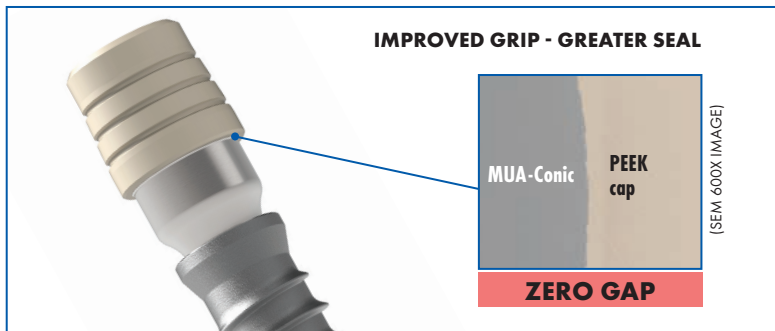
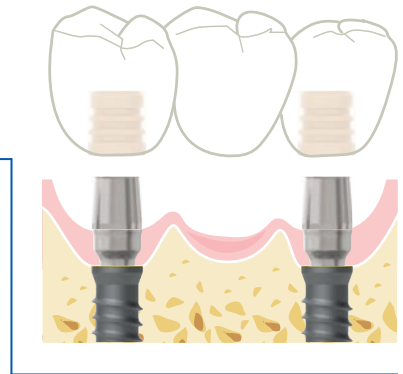

The pictures and illustrations in this brochure are for information purposes only and they are not intended to replace the methods or procedures for diagnosis and treatment planning of the Dental surgeon, Dentist and Dental Technician regarding the needs of each patient. Leone Spa disclaims any liability or any other obligation expressed or implied in this brochure.

TYPE
OF CAP

 RETENTION
SURFACE AREA

PREFORMED CONOMETRIC CAPS

4 different types of caps with different characteristics are available in order to offer an optimal solution for all clinical situations.

With the introduction of the new *LIGHT* cap, the range of conometric caps has been expanded in order to modulate the retention of both fixed and removable prosthesis according to the number of implants and prosthetic platforms (green, yellow).

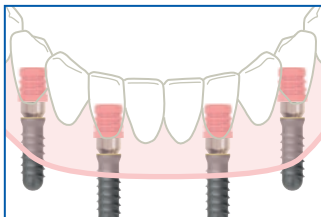
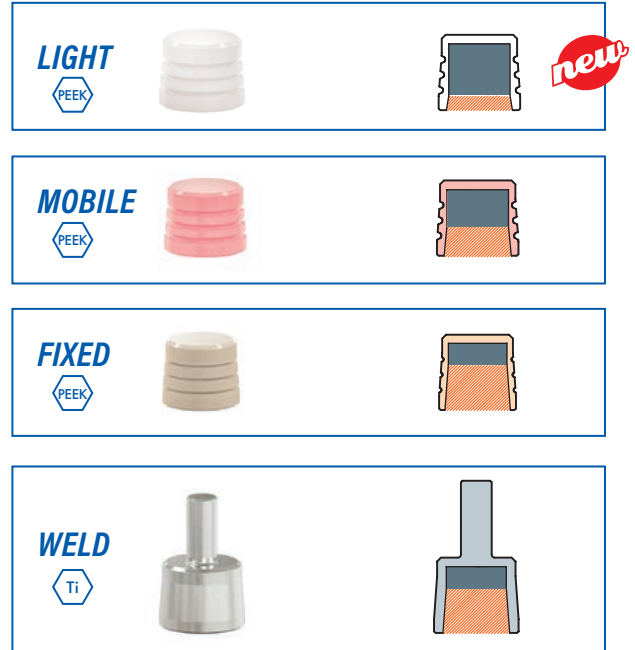

MOBIL cap - Removable prosthesis

An alternative to overdentures on ball head abutments that gives the patient the comfort of a fixed prosthesis.

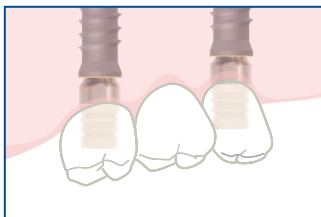

FIXED cap - Fixed bridges and fixed full-arch prosthesis

Easily removed by the clinician for hygiene in the dental office.

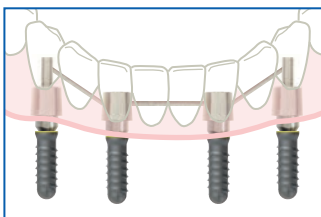

WELD Cap - Intra-oral welding technique

Weld caps placed on the abutments can be splinted together with a titanium wire through an intra-oral welding process: appreciated technique in immediate loading procedures.

CONIC ADAPTERS

FOR MUA

- made of medical grade 5 titanium
- tapered top with a half-angle of 5°
- supplied with specific colour-coded screw for attachment to the MUA
- autoclavable

Pack of 2

Necessary instruments:

- screw adapter with prosthetic hand screwdriver and torque instruments
- alternatively handpiece screwdriver
- activation of the locking-taper connection of the abutment with the abutment seater with straight or offset PEEK tip

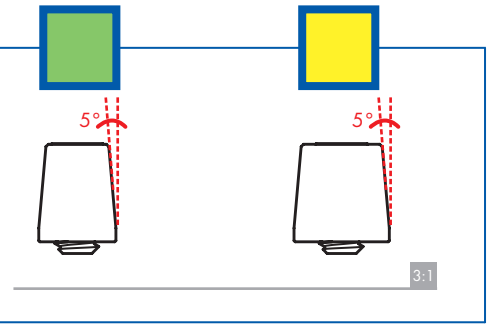

REF **123-4328-22**

123-4336-30

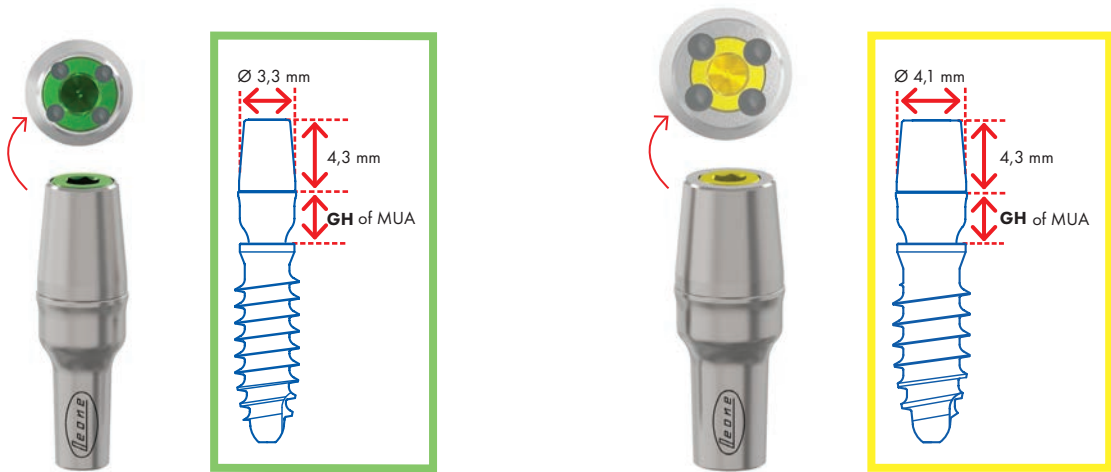

Prosthetic flexibility

The use of the MUA together with the Conic adapter makes the conometric XCN® restoration extremely flexible. They fit to any clinical situation, thanks to the wide range of angulations (0°, 7,5°, 15°, 25°, 35°) in different gingival heights (1,5 - 3 - 5 - 7 mm) and the XCN® 360° connection. Furthermore it makes possible to convert from a conometric-retained to a screw-retained restoration and vice versa, without having to remove the MUA.

For MUA and MUA Plus' catalogue codes, see pages 70 and 71.

LIGHT CAPS *patented*

- made of PEEK
- to reduce the total retention of the prosthesis
- wall thickness 0,6 mm
- autoclavable

Pack of 2

Necessary instrument:

activation of the connection with the abutment seater with straight or offset PEEK tip

new

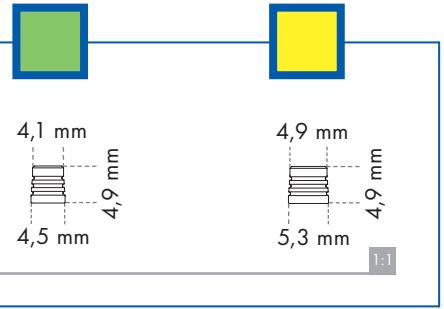

REF **161-4901-22**

161-4901-30

MOBILE CAPS *patented*

- made of PEEK
- for the fabrication of removable prostheses
- wall thickness 0,6 mm
- autoclavable

Pack of 2

Necessary instrument:

activation of the connection with the abutment seater with straight or offset PEEK tip

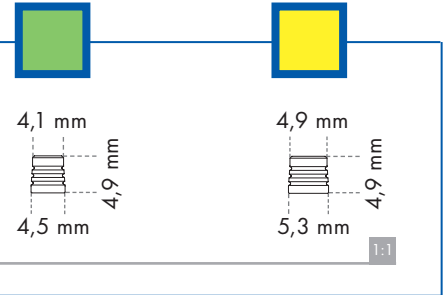

REF **161-4941-22**

161-4949-30

FIXED CAPS *patented*

- made of PEEK
- for the fabrication of fixed bridges
- wall thickness 0,4 mm
- autoclavable

Pack of 2

Necessary instrument:

activation of the connection with the abutment seater with straight or offset PEEK tip

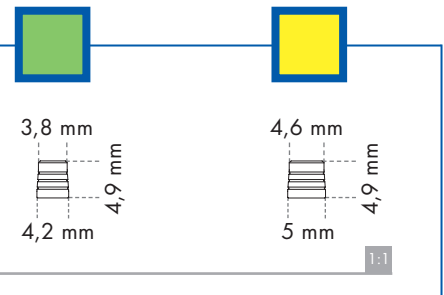

REF **161-4938-22**

161-4946-30

WELD CAPS

- made of medical grade 5 titanium
- for intraoral welding techniques
- wall thickness 0,7 mm
- autoclavable

Pack of 2

Necessary instrument:

activation of the connection with the abutment seater with straight or offset PEEK tip

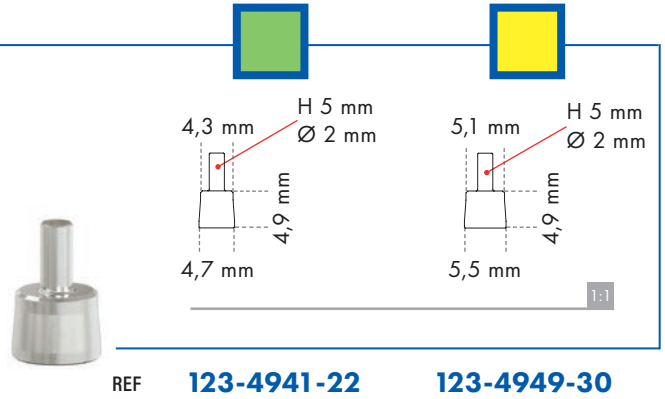

REF **123-4941-22**

123-4949-30

TITANIUM WIRES FOR WELDING

- made of medical grade 2 titanium
- for intra or extra-oral welding techniques
- Ø 1,5 mm: for distances among abutments ≤ 8 mm
- Ø 2 mm: for distances among abutments > 8 mm
- autoclavable

Pack of 5



REF **126-1515-00**

126-2015-00

MUA-CONIC TRANSFER

- made of PEEK
- to take an impression of the MUA-Conic connected to the implant
- for closed tray technique
- autoclavable

Pack of 2

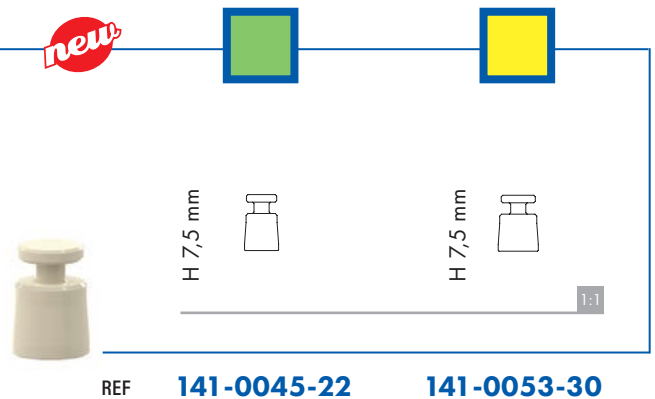

REF **141-0045-22**

141-0053-30

MUA-CONIC ANALOGS

- made of stainless steel
- to replicate in the dental cast the position of the MUA-Conic connected to the implant
- colour-coded

Pack of 1

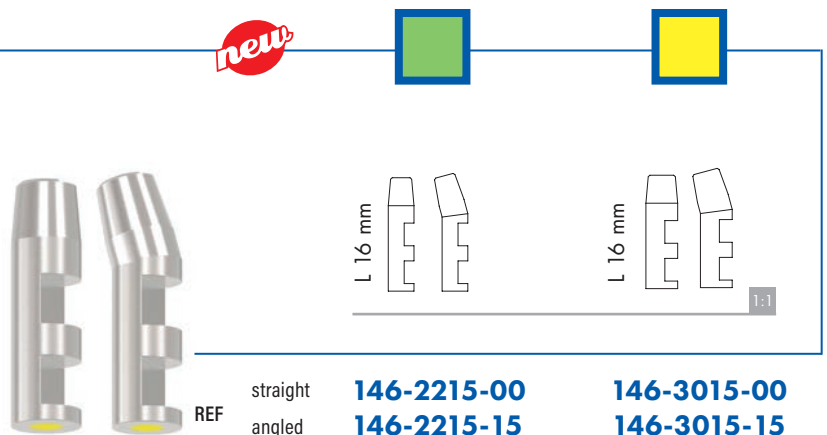

REF straight
angled

146-2215-00
146-2215-15

146-3015-00
146-3015-15

IMPLANT SYSTEM

XCN[®]

ABUTMENTS FOR
ATTACHMENT-RETAINED
PROSTHESIS
AND ACCESSORIES



BALL HEAD ABUTMENTS



Ideal for

- overdenture
- at least four supporting implants are required in the upper jaw
- at least two supporting implants are required in the lower jaw

Features

- made of medical grade 5 titanium
- ball-shaped top for the anchorage of a removable prosthesis with specific housings
- ball head \varnothing 2,15 mm
- autoclavable

Wear resistant

The ball head of the abutments is titanium nitride (TiN) coated to increase its wear resistance.

Simple hygiene

The ball head without blind holes and cavities, thanks to the absence of an abutment screw, facilitates daily hygiene.



Excellent prosthesis stability

The housing with insert has a large supporting surface on both the head and neck of the abutment, helping to prevent rocking of the overdenture.

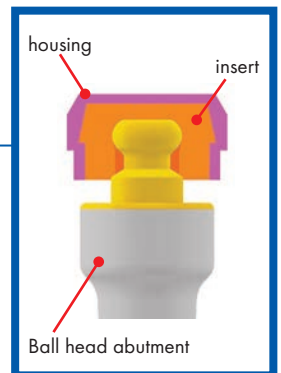

Easy parallelization

The Leone ball head abutments are available in straight and 15° angled version, with three different gingival heights.

The achievement of parallelism is also facilitated by the XCN® 360° connection of the angled abutments. The movable hexagon allows for 360° positioning on the dental cast and the permanent connection of the hexagon in the selected position guides the clinician in the accurate positioning in the mouth.

Wide range of housings

According to the needs of the case it is possible to choose between different housing types:

- **pink anodized titanium housings** for better aesthetics inside the prosthesis with elastomer retention inserts in three rigidities: soft (white), medium (orange), rigid (violet)
- **titanium housings with O-ring**
- **titanium micro housings with micro O-ring**

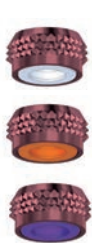

→ ANODIZED TITANIUM HOUSINGS with:
 - soft insert (white)
 - medium insert (orange)
 - rigid insert (violet)



→ TITANIUM HOUSINGS with O-Ring



→ TITANIUM MICRO HOUSINGS with micro O-Ring

Necessary instruments:

- selection of the most appropriate ball head abutment with the Abutment Gauges
- activation of the connection with the abutment seater with straight or offset titanium tip

Pack content:

- 1 abutment
- 1 hexagon (for the angled abutments only)
- 1 housing with O-ring
- 1 housing with orange insert
- 2 spacer rings for abutments



Ball head abutments

				1:1
Ø connection (mm)	2,2	2,2	2,2	
Ø prosthetic platform (mm)	3,3	3,3	3,3	
GH (mm)	1,5	3	5	
REF	straight 15° angled	123-3300-01 123-3315-01	123-3300-03 123-3315-03	123-3300-05 123-3315-05

Ball head abutments

				1:1
Ø connection (mm)	3,0	3,0	3,0	
Ø prosthetic platform (mm)	4,1	4,1	4,1	
GH (mm)	1,5	3	5	
REF	straight 15° angled	123-4100-01 123-4115-01	123-4100-03 123-4115-03	123-4100-05 123-4115-05

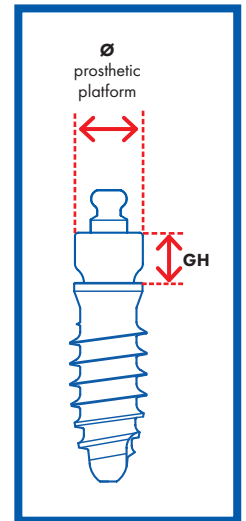

HOUSING WITH **SOFT INSERT** white

- housing made of medical grade 5 titanium
- with pre-mounted soft white insert
- retention force 5 N
- cold sterilization

Pack content:

- 2 housings with insert
- 2 spacer rings for abutments

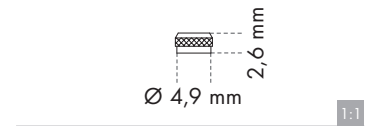

REF **123-0004-05**

SOFT INSERT white

- made of elastomeric material
- refill for housing with insert
- cold sterilization

Pack of 6



2:1

REF **123-0001-05**

HOUSING WITH **MEDIUM INSERT** orange

- housing made of medical grade 5 titanium
- with pre-mounted medium orange insert
- retention force 10 N
- cold sterilization

Pack content:

- 2 housings with insert
- 2 spacer rings for abutments

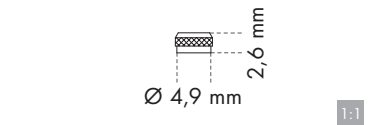

REF **123-0004-06**

MEDIUM INSERT orange

- made of elastomeric material
- refill for housing with insert
- cold sterilization

Pack of 6



2:1

REF **123-0001-06**

HOUSING WITH **RIGID INSERT** violet

- housing made of medical grade 5 titanium
- with pre-mounted rigid violet insert
- retention force 15 N
- cold sterilization

Pack content:

- 2 housings with insert
- 2 spacer rings for abutments

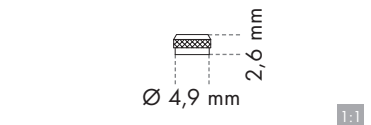

REF **123-0004-07**

RIGID INSERT violet

- made of elastomeric material
- refill for housing with insert
- cold sterilization

Pack of 6



2:1

REF **123-0001-07**

INSERT SEATING TOOL

- made of stainless steel
- used to place the insert inside its housing

Pack of 1



REF **156-1004-00**

HOUSING WITH O-RING

- made of medical grade 5 titanium
- with pre-mounted O-ring
- retention force 10 N
- autoclavable

Pack content:

- 1 housing with O-ring
- 1 spacer ring for abutments

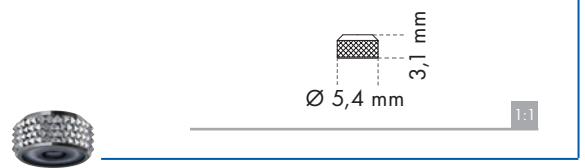

REF **123-0002-00**

O-RING

- made of elastomeric material
- refill for housing with O-ring
- inner hole \varnothing 1,5 mm
- outside \varnothing 4,4 mm
- autoclavable

Pack of 10



REF **123-0001-00**

MICRO HOUSING WITH MICRO O-RING

- made of medical grade 5 titanium
- with pre-mounted micro O-ring
- retention force 10 N
- autoclavable

Pack content:

- 1 micro housing with micro O-ring
- 1 spacer ring for abutments (grey)
- 1 spacer ring for monoimplants (white)

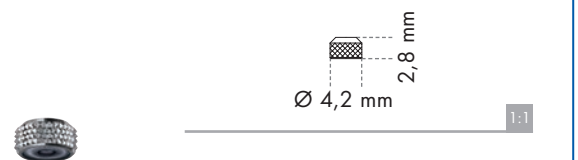

REF **123-0003-00**

MICRO O-RING

- made of elastomeric material
- refill for micro housing with micro O-ring
- inner hole \varnothing 1,5 mm
- outside \varnothing 3,6 mm
- autoclavable

Pack of 10



REF **123-0001-01**

ABUTMENT GINGIVAL HEIGHT DIMENSIONS

It is possible to consult the tables regarding the gingival height dimensions of the Leone abutment range by scanning the QR codes with your smartphone, or by connecting to the following link: www.leone.it/english/info-transmucoso



360° ANATOMICAL

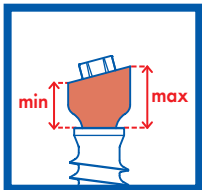

EXACONNECT

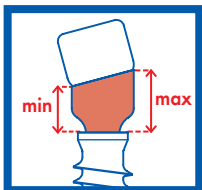

EXACONNECT *Plus*

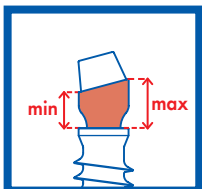

MUA / MUA-CONIC

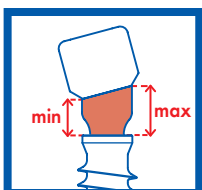

MUA *Plus*

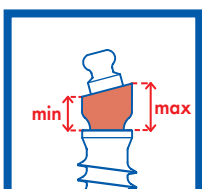

BALL HEAD

new

Features

- made of PPSU plastic material
- contains basic instruments for selecting, activating and removing abutments
- large availability of silicone grommets to collect additional prosthetic instruments
- simple, intuitive design with marked lines identifying the position of each instrument
- tilted position after opening for easy access to instruments
- Ø 2 mm silicone grommets
- entirely autoclavable

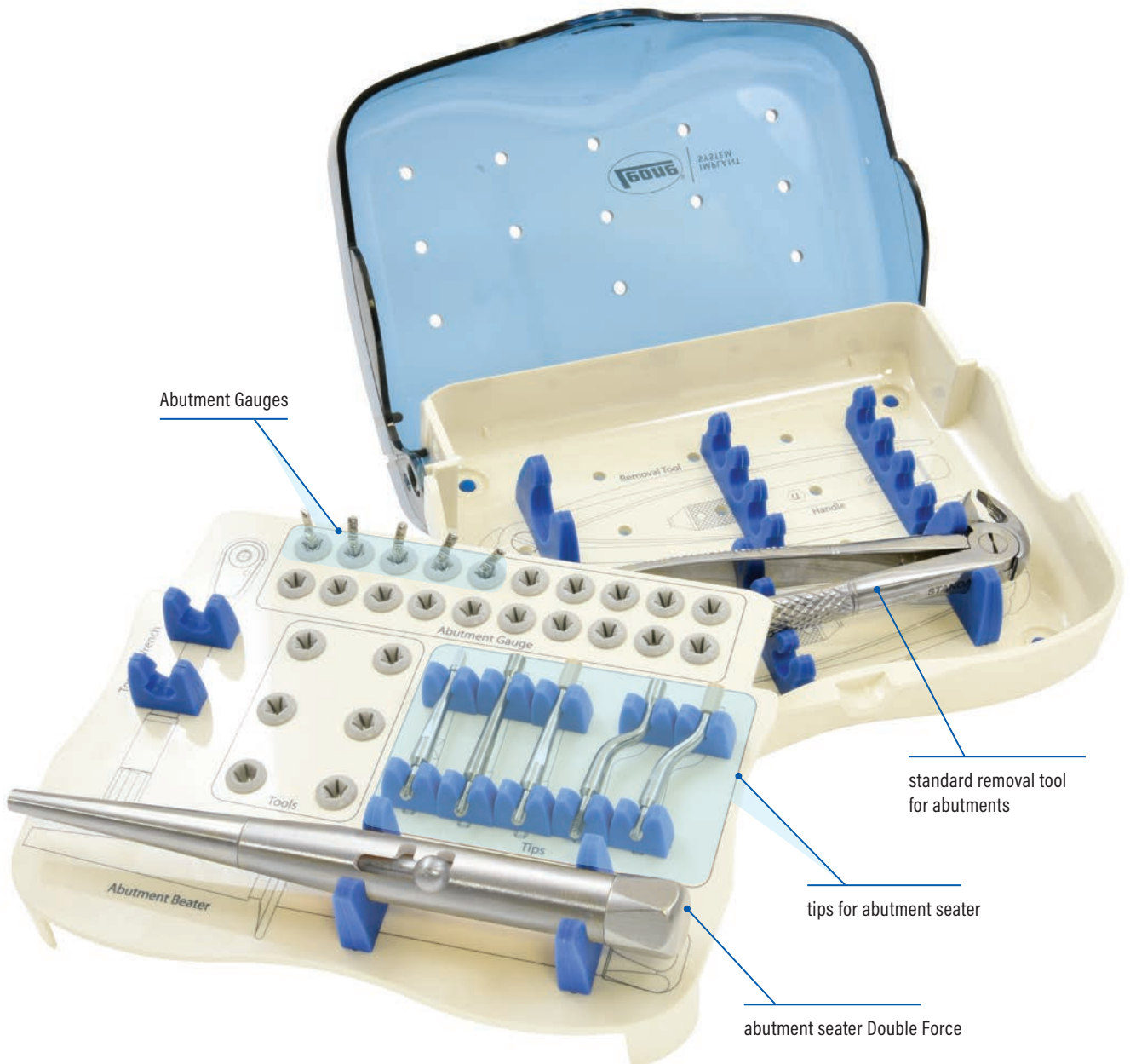

**COMPREHENSIVE
PROSTHETIC INSTRUMENT KIT**

REF **156-0070-01**

Kit content

- 1 straight Abutment Gauge
- 1 7,5° angled Abutment Gauge
- 1 15° angled Abutment Gauge
- 1 25° angled Abutment Gauge
- 1 35° angled Abutment Gauge
- 1 Abutment seater Double Force
- 1 straight titanium tip
- 1 straight PEEK tip
- 1 offset titanium tip
- 1 offset PEEK tip
- 1 flat stainless steel tip
- 1 Standard removal tool for abutments

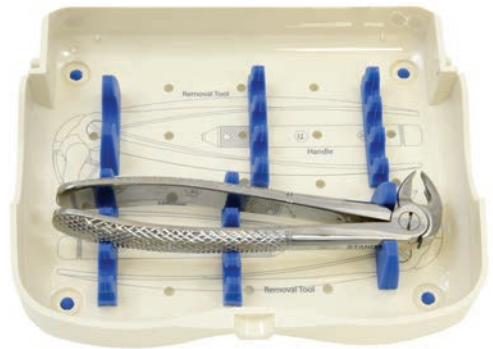

**PROSTHETIC INSTRUMENT KIT
WITHOUT CONTENT**

REF **156-0070-00**



ABUTMENT GAUGE

- made of stainless steel
- one instrument for two functions: measurement of soft tissue thickness and selection of the most appropriate abutment angulation
- for universal use, suitable for all abutment types and for both connection diameters, green and yellow
- the apical split cylinder ensures excellent retention in the internal hexagon of the implant/analog allowing for free rotation to 360°
- ideal for immediate loading procedures
- with a hole for the placement of a safety leash
- autoclavable for safe use in the dental office and in the laboratory

Pack of 1

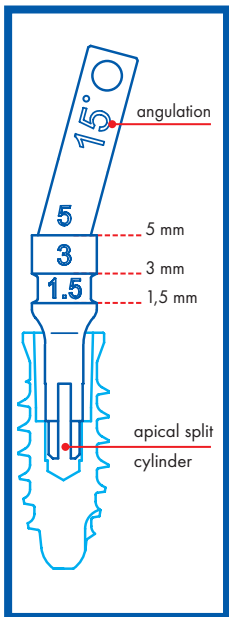

2:1

REF **141-0000-00** **141-0075-00** **141-0015-00** **141-0025-00** **141-0035-00**

ORGANIZER FOR ABUTMENT GAUGES

- made of PPSU plastic material
- entirely autoclavable

Pack content:

- 1 abutment Gauge 0°
- 1 abutment Gauge 7,5°
- 1 abutment Gauge 15°
- 1 abutment Gauge 25°
- 1 abutment Gauge 35°



REF **141-0001-03**

new



ABUTMENT SEATER DOUBLE FORCE

- made of stainless steel
- equipped with two slots for two activation force release options: FULL and HALF
- the new activation method allows for greater precision in the application of activation force
- particularly indicated in the aesthetic area and for angled abutments
- interchangeable seating tips
- autoclavable

Pack content:

- 1 abutment seater
- 1 straight PEEK tip
- 1 flat stainless steel tip



REF **156-1008-10**

ABUTMENT SEATER

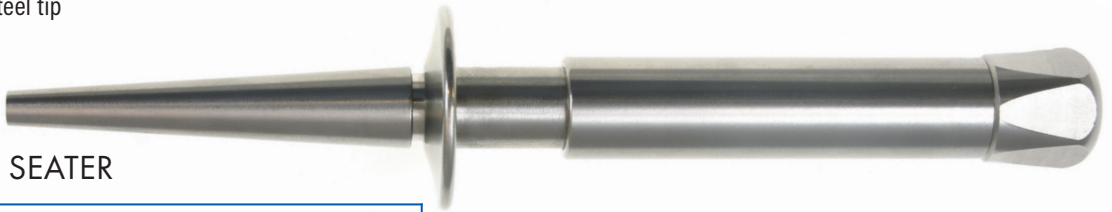

- made of stainless steel
- provides the right percussive force to seat the healing cap and the abutment into the implant
- to activate the connection between the preformed conometric cap and the MUA-Conic
- interchangeable seating tips
- autoclavable

PACK WITH STRAIGHT TIPS:

- 1 abutment seater
- 1 straight titanium tip
- 1 straight PEEK tip

PACK WITH OFFSET TIPS:

- 1 abutment seater
- 1 offset titanium tip
- 1 offset PEEK tip

WITH STRAIGHT TIPS

REF **156-1008-03**



WITH OFFSET TIPS

REF **156-1008-04**

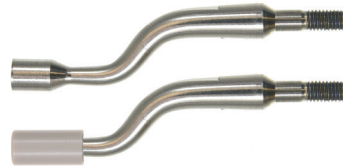

SEATING TIPS

- made of medical grade 5 titanium, stainless steel and PEEK
- to be screwed onto the abutment seater
- **straight tips:** for the anterior region
- **offset tips:** for the posterior region
- **PEEK tips:** for ceramic crowns, MUA, ExaConnect, MUA-Conic and preformed conometric caps
- **flat tip:** for angled abutments for cement-retained prosthesis
- autoclavable

Pack of 1

straight titanium tip

REF **156-1008-01**



straight PEEK tip

REF **156-1008-08**



offset titanium tip

REF **156-1008-02**



offset PEEK tip

REF **156-1008-09**



flat stainless steel tip

REF **156-1008-06**



HEX HEAD EXTRACTOR FOR HEALING CAPS

- made of stainless steel
- to unlock the healing cap and thus permit its removal
- hexagon on both ends for easy use in all situations
- autoclavable

Pack of 1



REF **156-1006-00**

WEINGART STYLE PLIERS

- made of stainless steel
- to firmly hold the abutment during try-in phases
- with rounded and ribbed tips for a safe grip of the abutment
- autoclavable

Pack of 1



REF **P2104-00**

REMOVAL TOOL FOR ABUTMENTS

- made of stainless steel
- allows the application of the extraction force necessary to remove a definitively seated abutment from the implant
- **two models:** one for all abutments of the Standard prosthetic platform and one for all abutments of the Large prosthetic platform
- autoclavable

Pack of 1



REF **156-1022-01** **standard**
REF **156-1022-02** **large**

*For more details download
the "Procedure of removal
of the Leone abutments"*

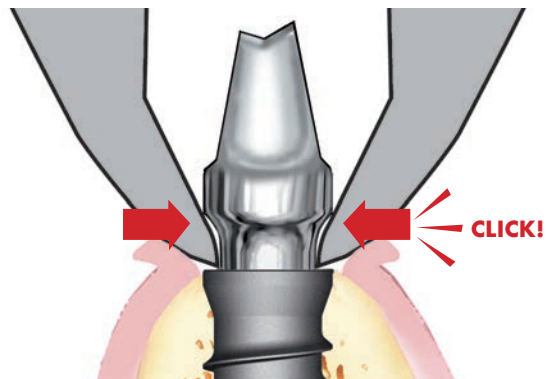

HANDPIECE SCREWDRIVER

new

- made of stainless steel
- to tighten and loosen the connecting screws and the Conic adapter with the contra-angle handpiece
- do not use with a torque value higher than 20 Ncm
- autoclavable

Pack of 1



1:1

REF **156-1002-03**

SCREW ADAPTERS

- made of stainless steel
- for use with the prosthetic hand screwdriver, the prosthetic torque wrench and the lab torque screwdriver to tighten and loosen the connecting screws, the healing screws, the Conic adapter, the transfer for ExaConnect and the Pick-up transfer for MUA
- autoclavable

Pack content:

- 1 screw adapter
- 1 prosthetic hand screwdriver

L 12,5 mm



L 20 mm



1:1

REF **126-0003-00**

126-0003-01

PROSTHETIC HAND SCREWDRIVER

- made of medical grade 5 titanium
- for use with the specific screw adapter to hand tighten and loosen the connecting screws, the healing screws and the Conic adapter
- with a hole for the placement of a safety leash
- autoclavable

Pack of 1



1:1

REF **156-1001-00**

PROSTHETIC TORQUE WRENCH 20 Ncm

- made of stainless steel
- for use with the specific screw adapter to tighten and loosen the connecting screws and the Conic adapter with a torque of 20 Ncm
- two-way function: to screw in and unscrew
- can be disassembled for cleaning
- autoclavable

Pack of 1



1:1

REF **156-1014-26**

**TORQUE SCREWDRIVER 20 Ncm
FOR LABORATORY**

- made of stainless steel
- for use with the specific screw adapter to tighten the connecting screws and the Conic adapter with a torque of 20 Ncm
- two-way function: to screw in and unscrew
- do not disassemble for cleaning
- autoclavable

Pack of 1



1:1

REF **156-2006-00**

HANDLE FOR ABUTMENTS

- made of medical grade 5 titanium
- for use during abutment preparation in the laboratory and in the dental office

Pack of 1



for abutment with \emptyset connection (mm)

2,2

1:1

REF **156-1007-33**



for abutment with \emptyset connection (mm)

3,0

1:1

REF **156-1007-41**

IMPLANT SYSTEM

XCN[®]

DEMONSTRATION AND
INFORMATIVE MATERIAL



SURGICAL DEMONSTRATION KIT

- to simulate the most relevant surgical and prosthetic phases of the XCN® implant system
- intended for demonstration use only

Pack content:

- 1 hemi-mandible
- 1 Classix implant Ø 4,1 mm (non-sterile) 10 mm long with cover cap and 5 cover cap refills connection 3,0
- 1 instrument for cover caps
- 1 Standard healing cap connection 3,0 GH 3 mm
- 1 Standard transfer connection 3,0
- 1 surgical hand screwdriver
- 1 hex head extractor
- 1 straight Standard Basic abutment connection 3,0



REF **106-0002-00**

HEMI-MANDIBLE

- made of polyurethane
- presents a hole for the placement of a Classix implant Ø 4,1 mm, 10 mm long

Pack of 1



REF **106-0001-00**

DEMONSTRATION JUMBO DENTAL IMPLANT

- made of aluminium
- scale 5:1 reproduction of straight Standard Basic abutment connection 3,0 and Classix implant Ø 4,1, 10 mm long
- use the rod included in the package for removal of the abutment from the Jumbo implant. A hole is present in the back of the implant for the rod

Pack of 1



REF **106-0003-00**

IMPLANT CARD

- supplied with each implant
- for unique identification of the placed implant
- for delivery to the patient
- contains essential information in case of dental care away from home or abroad



PATIENT INFORMATION BROCHURE

- available on request
- Pack content:** 50 brochures in a carton box



IMPLANT SYSTEM

XCN[®]

**SURGICAL
PROCEDURE**



The pictures and illustrations in this brochure are for information purposes only and they are not intended to replace the methods or procedures for diagnosis and treatment planning of the Dental surgeon, Dentist and Dental Technician regarding the needs of each patient. Leone Spa disclaims any liability or any other obligation expressed or implied in this brochure.

DISCLAIMER

The Surgical Procedure and the use of the products of the XCN® Leone Implant System described in the following pages are intended for Professionals experienced in dental implant techniques.

In case of lack of basic notions, we suggest to attend specific courses in order to reach a high level of knowledge and practice in the use of implants. The rules on the use of the products described below represent a group of standard instructions that must be adjusted to the single needs and to the particular situations that may occur according to the manual ability, to the experience and to the diagnosis made by the legally qualified medical operator.

It is not ascribed to the manufacturer the duty of monitoring the procedures of use of the product. A correct and appropriate use of the instruments and products related to the XCN® Leone Implant System shall completely be reverted to the clinician. The surgical procedure hereunder described is merely indicative as any single treatment case is assigned to the experience of the operator.

As every medical operator well knows, a correct procedure and a perfect manufacture of the prosthesis may sometimes be followed by not satisfactory results owing to particular situations not imputable to responsibility of the dental operator or the manufacturer.

TREATMENT PLANNING

Indications

SINGLE-TOOTH EDENTULISM, DISTAL EDENTULISM, MULTIPLE EDENTULISM, TOTAL EDENTULISM.

Contraindications

For contraindications and side effects read the instructions for use enclosed in the package of each product and available in our web site www.leone.it in the section **Services/Quality**

PREOPERATORY EXAMS

Before starting the surgical intervention, the patients have to be subjected to a series of exams; single cases have to be evaluated in the opinion of the clinician.

Anamnesis

It is the first approach to the patient and it represents a fundamental tool to recognize both risk factors and contraindications. Moreover, anamnesis allows for the evaluation of patient's expectations and priorities and of patient's degree of compliance and motivation. Anamnesis can help in evaluating the need for extra exams in addition to the routine ones (when the presence of pathologies that were not reported by the patient is suspected) and when particular situations drive to deem a complete medico-surgical exam may be necessary.

Objective exam

It consists of:

- inspection of the periodontal tissues, of the oral mucosa and of the teeth along with an initial evaluation of the occlusal relationships (skeletal Class, characteristics of the opposing arch and related potential problems, type of occlusion, interarch distance), of the presence of parafunctions, of the degree of oral hygiene, of the aesthetic conditions, of the morphology of the edentulous crest and the space available for the replacement of the prosthesis.
- palpation of the soft tissues and implant sites for a preliminary evaluation of the bone morphology and thickness.
- a complete periodontal probing for the appraisal of the absence of both gingivitis and pockets
- Examination of the dental casts mounted in an articulator for a comparison with the information derived from previous exams, creation of a diagnostic set-up, and, if necessary, the implementation of a surgical template.

Radiographic exams

PANORAMIC RADIOGRAPH: frequently, this radiograph allows an appraisal of the bone height and the relationships between implant site and adjacent structures, such as maxillary sinuses, nasal cavities, and mandibular canal. It is also possible to identify concavities and ossification defects due to previous tooth extractions.

INTRAORAL RADIOGRAPH: it is very helpful for the determination of the mesio-distal distance between the roots, and the apico-coronal availability of bone.

LATERAL CEPHALOGRAM: it is useful when interventions on the mandibular symphysis are planned.

COMPUTERIZED TOMOGRAPHY CONE BEAM: it is advisable to remind that previous radiographic exams provide two-dimensional images which do not give information on bone thickness. In order to obtain this useful information a Cone Beam computerized tomography (CBCT) is necessary: it provides three-dimensional images, thus allowing for an accurate evaluation of bone morphology and, sometimes, bone density.

Instrumental or laboratory exams or medical advices

When necessary, in cases where a pathology is suspected on the basis of anamnesis or clinical records.

IMPLANT SELECTION

The number and dimensions (diameter and length) of the implants to be used are determined by the following factors:

1. amount of bone available
 2. characteristics of the implant site
 3. masticatory load
 4. aesthetic results
 5. type of the prosthetic restoration
 6. type of the surgical procedure followed
- Further and particular single situations must be evaluated by the clinician.

For the evaluation of implant treatment with the Leone system, XCN implants are included in the libraries of the most popular dental software for implant treatment planning and 3D radiographic diagnostics.

In addition, templates are available in which XCN Leone implants are represented in various scales: actual dimensions, increased by 10% and increased by 25% to match distortions created by the X-ray unit.

Small diameter implants (implant-abutment connection 2.2) are not recommended for the posterior region.

Small diameter implants, 8 mm long, are intended for use as a support in prosthesis composed of two or more implants of any diameter and length.

In case of single implants, **do not** fabricate restorations with mesial or distal cantilever extensions.

Do not place the **Max Stability implants** in thick cortical bone, equivalent to D1 bone density according to Misch Classification.^[1]

The **2.9 Narrow implant** is suitable for cases with very narrow spaces. It is mainly indicated for narrow bony ridges and for limited interdental spaces in the anterior region, specifically for the upper lateral incisors and lower central and lateral incisors.

The use of the **6.5 Short implant** shall be restricted to cases with limited vertical bone availability.

It is not intended to be associated with sinus lift procedures, immediate loading or one-stage surgical technique.

XCN® IMPLANTS ARE INTENDED FOR PLACEMENT AT THE LEVEL OF ALVEOLAR CREST OR BELOW THE LEVEL OF ALVEOLAR CREST UP TO 2 mm SUBCRESTALLY. DO NOT PLACE LEONE IMPLANTS ABOVE THE LEVEL OF ALVEOLAR CREST.

^[1]Misch CE, Density of bone: effect on treatment plans, surgical approach, healing and progressive bone loading, Int J Oral Implant 1990; 6:23-31

XCN® implant system is characterized by high mechanical strength, validated through fatigue testing performed according to ISO 14801 standard.^[2]

The results are:

- Narrow implants Ø 2.9 mm: **220 N**;
- Classix implants Ø 3.3 mm and Max Stability implants Ø 3.75 mm: **240 N**;
- Classix implants Ø 4.1 mm, Max Stability implants Ø 4.5 mm, Short 6.5 implants, Classix implants Ø 4.8 mm: **392 N**.^[3, 4]

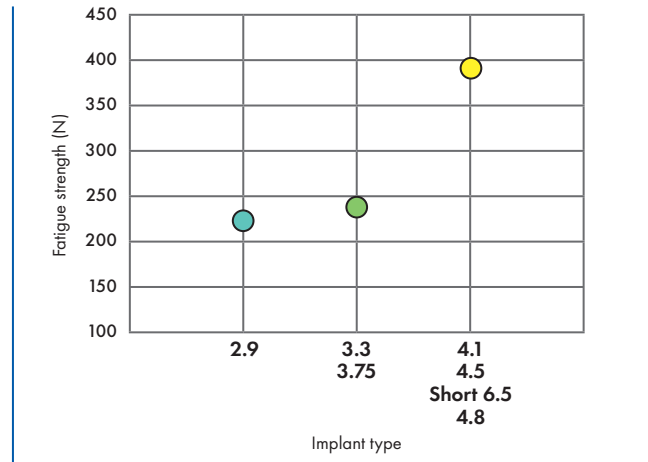

In the literature, in comparison, it is reported that the average force generated during mastication is 145 N with inclinations within 10°.^[5, 6] It should also be stressed that very high masticatory forces^[7, 8] can be generated due to many individual and prosthetic factors, such as crown height, cantilever and restoration type, which locally can exceed the strength limit of the implants, especially in case of single or unsplinted implants.

[2]ISO 14801:2007 (E), Dentistry - Implants - Dynamic fatigue test for endosseous dental implants, International Organization for Standardization, Geneva, 2007

[3]Barlattani A, Sannino G, Mechanical evaluation of an implant-abutment self-locking taper connection: finite element analysis and experimental tests, Int J Oral Maxillofac Implants 2013;28:e17-e26

[4]Gervasi G, Impianto Leone Exacone 2,9 mm: caratteristiche e comportamento biomeccanico, Exacone News 25, 2017:18-22

[5]Carlsson GE, Haraldson T, Functional response, In: Branemark P-I, Zarb GA, Albrektsson T, Eds. Tissue integrated prostheses. Osseointegration in clinical dentistry. Chicago: Quintessence, 1985:155-63

[6]Graf H, Occlusal forces during function, In: Proceedings of Symposium on Occlusion: Research on Form and Function. University of Michigan School of Dentistry, Ann Arbor: Rowe NH (Ed.), 1975:90-111

[7]Craig RG, Restorative dental material, 6th ed. St. Louis, C.V. Mosby, 1980

[8]Peck CC, Biomechanics of occlusion - implications for oral rehabilitation, J Oral Rehabil 2016;43(3):205-214

LEONE SURGICAL INSTRUMENTS ARE SUPPLIED NON-STERILE: CLEANING, DISINFECTION AND STERILIZATION AFTER REMOVAL FROM THE PACKAGE AND PRIOR TO EACH FURTHER USE ARE REQUIRED. CONSULT THE "Guidelines for Cleaning, Disinfection and Sterilization of reusable XCN® Leone instruments" AVAILABLE FOR DOWNLOAD AT www.leone.it IN THE SECTION Services/Quality.

The Surgical Procedure reported was conceived with the invaluable contribution of Dr. Leonardo Targetti, whom we thank sincerely.



Interactions between dental implant and medical imaging techniques

Titanium dental implants hardly cause pulling or heating sensation for the patient during Magnetic Resonance Imaging (MRI) and the artifacts on the bioimage are usually attributable to the implant-prosthetic device. For further details please refer to the document "Interactions between Leone orthodontic and implantology devices and medical imaging techniques" available for download at www.leone.it in the section **Services/Quality**.

XCN® IMPLANT PACKAGING

- double protection to preserve the sterility of the implant subjected to a certified gamma x-ray process
- 4 peel-off labels (2 with UDI Data Matrix) for:
 - the "Implant Card" to be delivered to the patient
 - the communication with the prosthetic team
 - the clinical case sheet of the patient
 - the inventory management
- with sterility indicator on the vial



STERILE BARRIER: VIAL

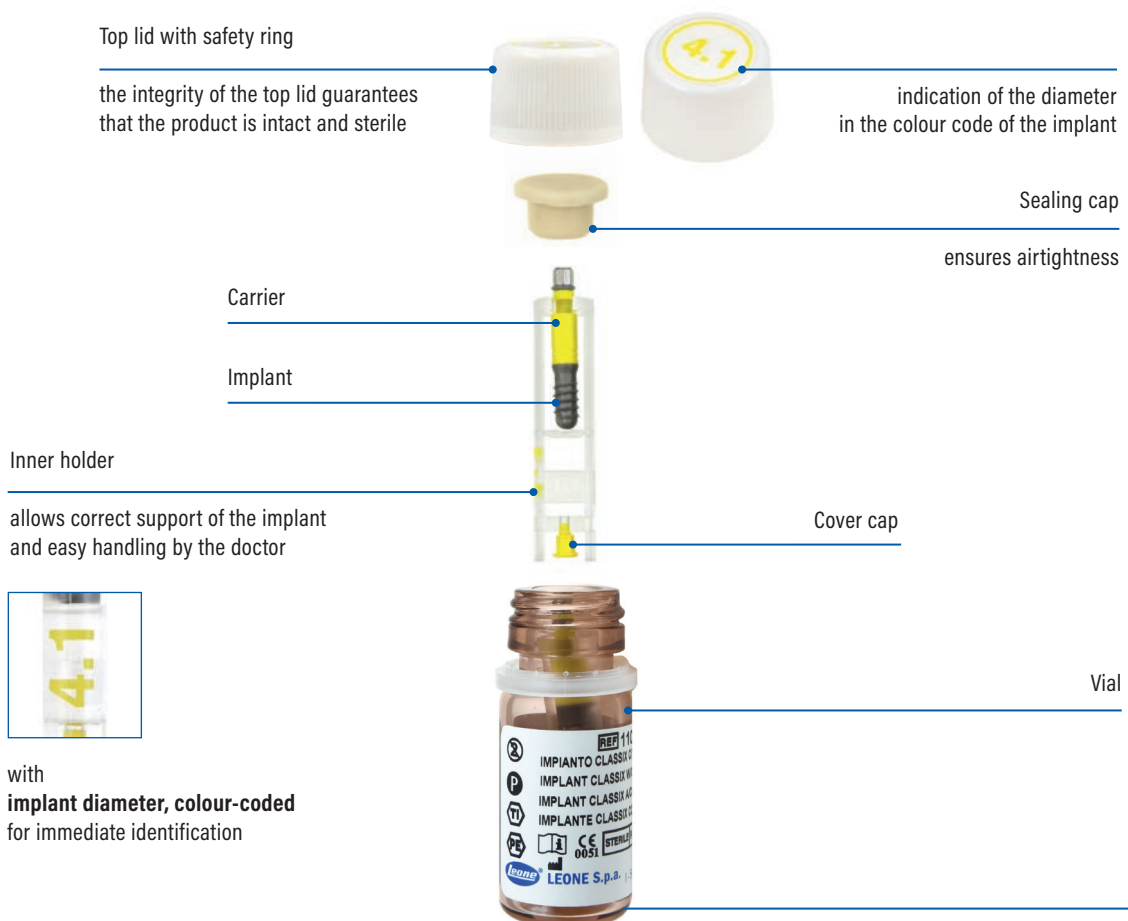

CARRIER FOR XCN® IMPLANTS

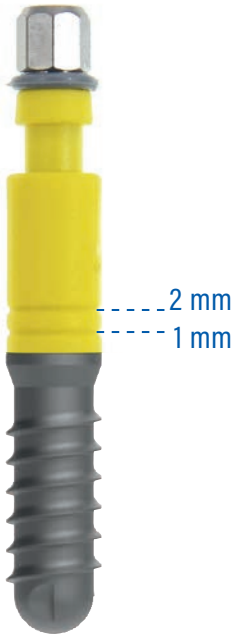

Pre-mounted on each XCN® implant

- it maintains the implant suspended within the inner holder and prevents contact with the glass vial and the sterile field
- it enables the secure transfer of the implant into the mouth

Colour-coded for instant identification

- the titanium core is covered by a biopolymer outer shell in the colour code of the implant

With depth indicators

- at 1 and 2 mm for better visibility when inserting the implant below the level of alveolar crest

With torque limiting device

- the torque limiting device makes the carrier break above the connection with the implant at 60 Ncm and then permits the removal of the carrier

Easy removal

- it is removed together with the insertion device after implant placement

Suitable as paralleling pin

- it is possible to place the carrier again on the implant to check the parallelism with natural teeth and/or adjacent implant sites

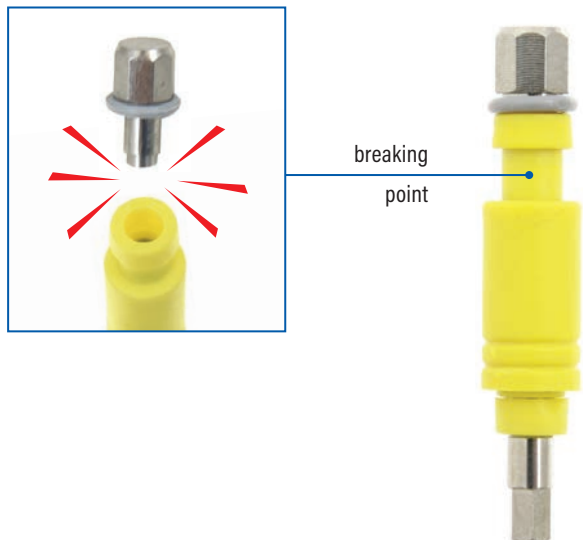

REMOVAL OF XCN® IMPLANT FROM THE VIAL

- open the vial's top lid and extract the inner holder with the implant and cover cap on a sterile pad

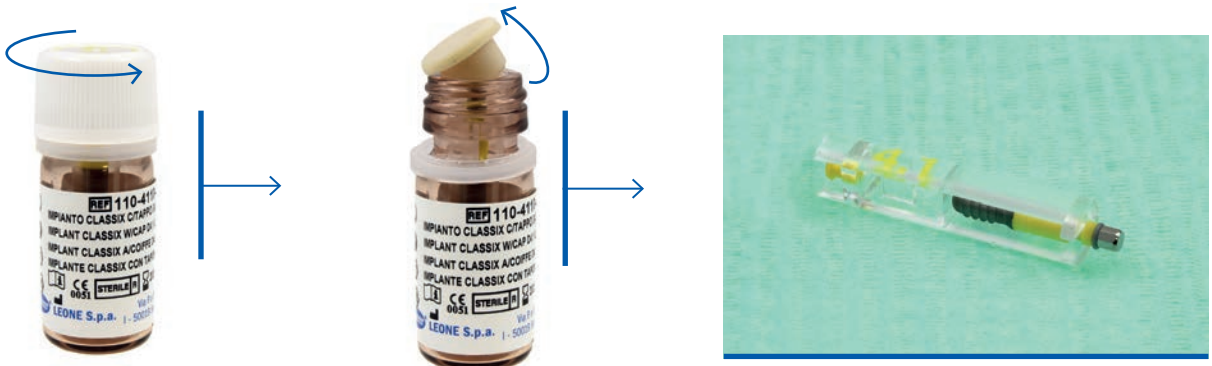

- connect the handpiece adapter to the carrier of the implant and remove the implant from the holder

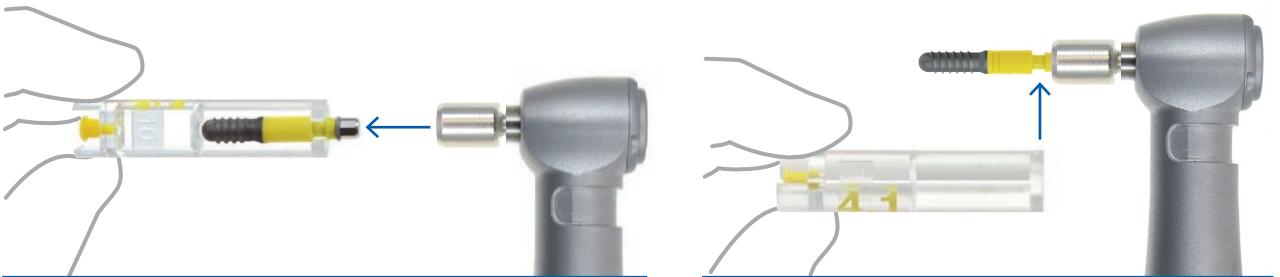

- for a manual placement, connect the surgical hand screwdriver to the implant carrier and remove the implant from the holder

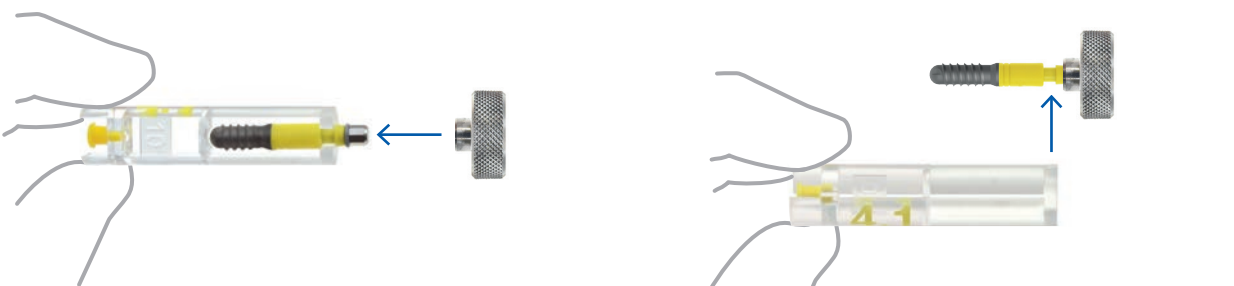

DRILLING DEPTH

- the length of the drill tip (max. 1 mm) is not included in the depth mark measurements on the pilot and twist drills



DEPTH STOPS FOR SHORT DRILLS

Mounting of depth stop:

- insert the drill's tip into the hole of the drill stop kit corresponding to the diameter, the colour of the instrument and the selected depth
- push the drill all the way down to set the stop into position
- verify that the stop is positioned at the correct height

Note: if a stop loses stability, slightly tighten the clamping mechanism with tweezers

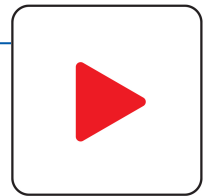

Removal of depth stop*:

- insert the drill shank into the specific slot of the drill stop kit corresponding to the diameter of the drill
- place the specific PEEK tool for stop removal onto the tip of the drill and push down to remove the stop

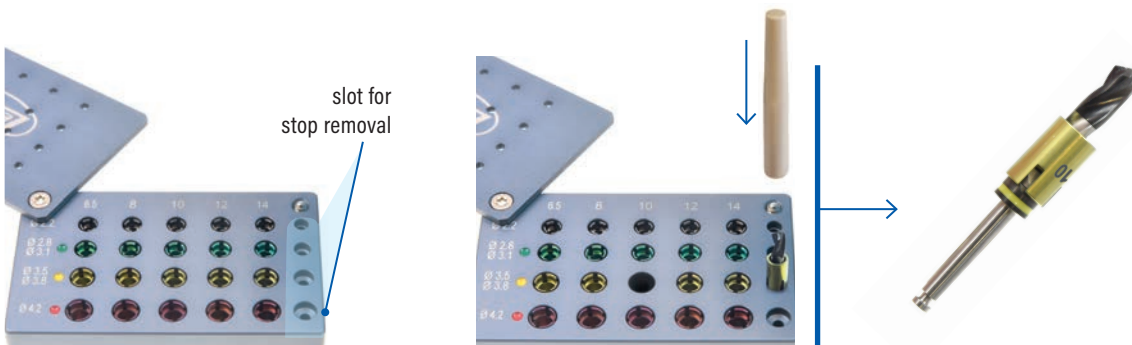

*Depth stops must be removed from the drills before cleaning, disinfection and sterilization.

DRILLING PROTOCOL FOR CLASSIX IMPLANTS

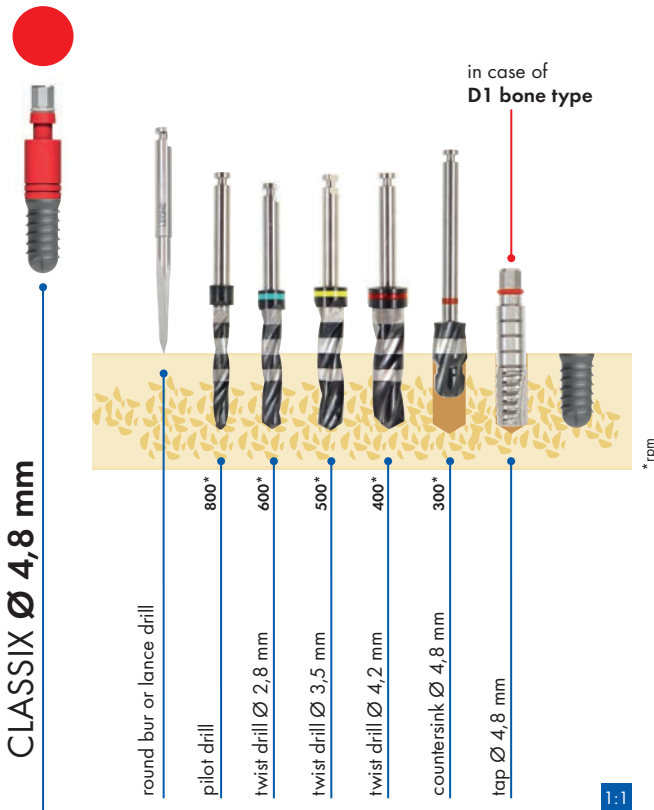
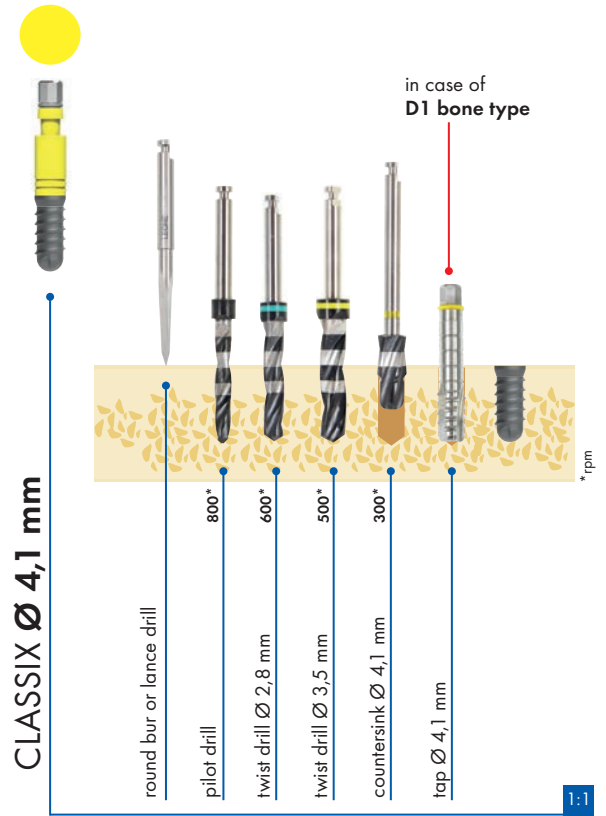
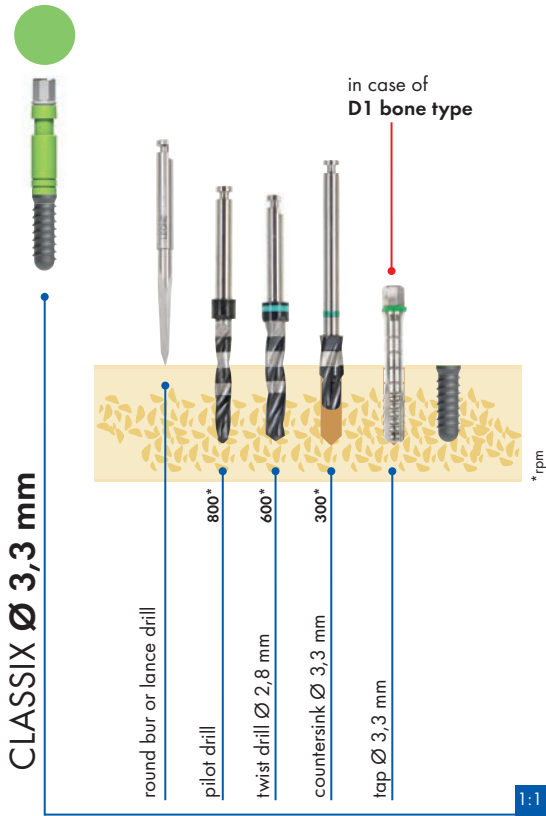

HIGH BONE DENSITY - D1 BONE TYPE:
 - the use of the tap is recommended

DRILLING PROTOCOL FOR **MAX STABILITY** IMPLANTS

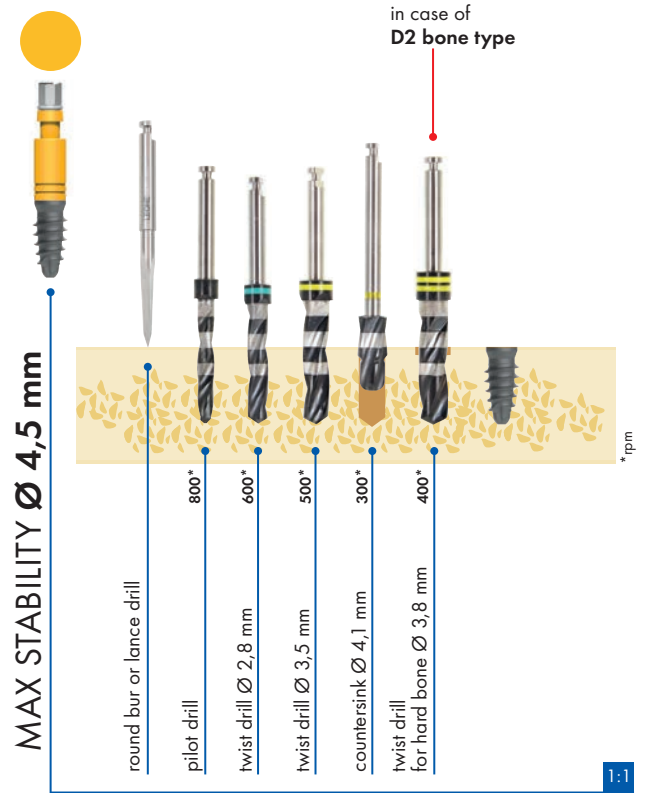
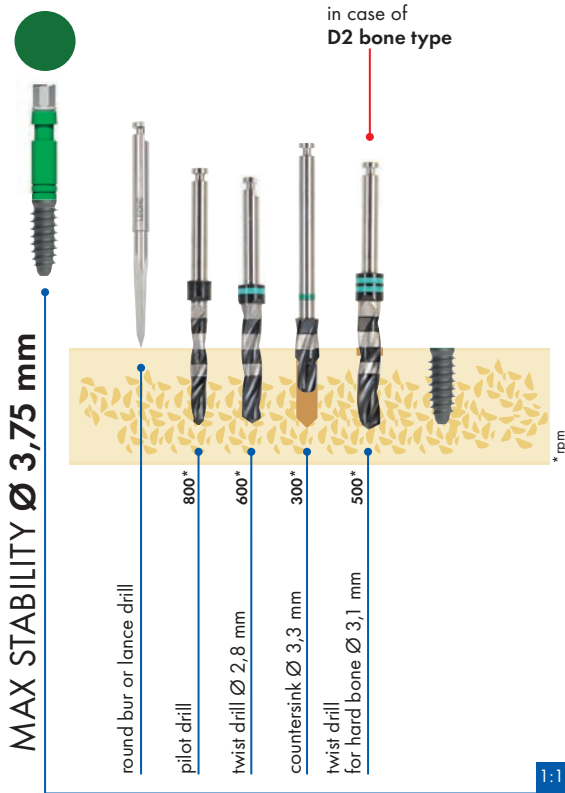

Do not use Max Stability implants in thick cortical bone, equivalent to D1 bone type.

**MEDIUM-TO-HIGH BONE DENSITY
D2 BONE TYPE:**

- it is necessary to use a twist drill with a larger diameter than the largest previously used, easily distinguishable by the two colour-coded marks on the shank.

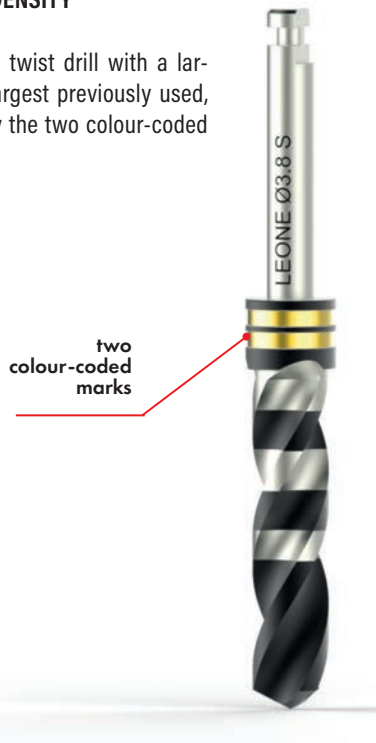

**FOR BETTER MAINTENANCE OF
IMPLANT SITE AXIS:**

- the use of the handpiece for the insertion of Max Stability implants is recommended.



DRILLING PROTOCOL FOR **2.9 NARROW** IMPLANTS

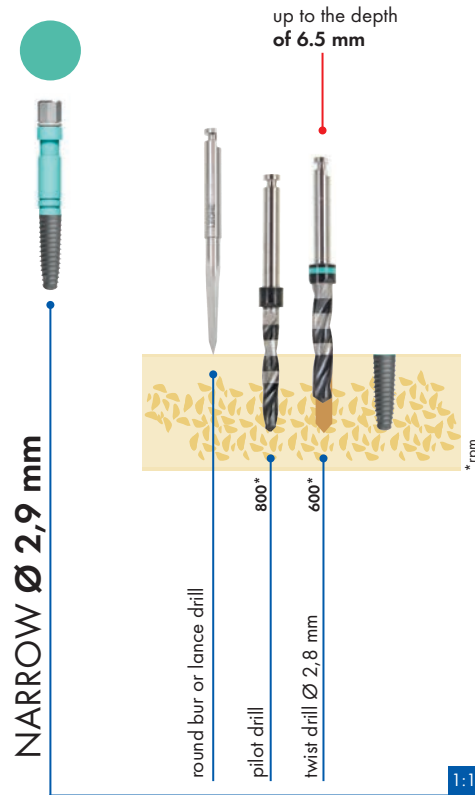

Ø 2,8 MM TWIST DRILL:

- use up to a depth of 6.5 mm for final sizing of the implant site. This depth is the same for all the three lengths of 2.9 Narrow implant.

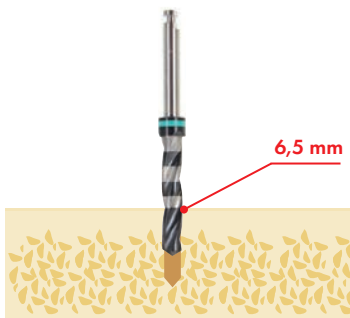

HIGH BONE DENSITY - D1 BONE TYPE:

- it is necessary to use the Ø 2,8 mm twist drill up to 2 mm less than the length of the selected implant (e.g. implant L = 10 mm, drill up to a depth of 8 mm).



SUBCRESTAL IMPLANT PLACEMENT:

- use the Ø 3,3 mm countersink to allow a complete seating of the healing cap or the abutment.



DRILLING PROTOCOL FOR **6.5 SHORT IMPLANT**

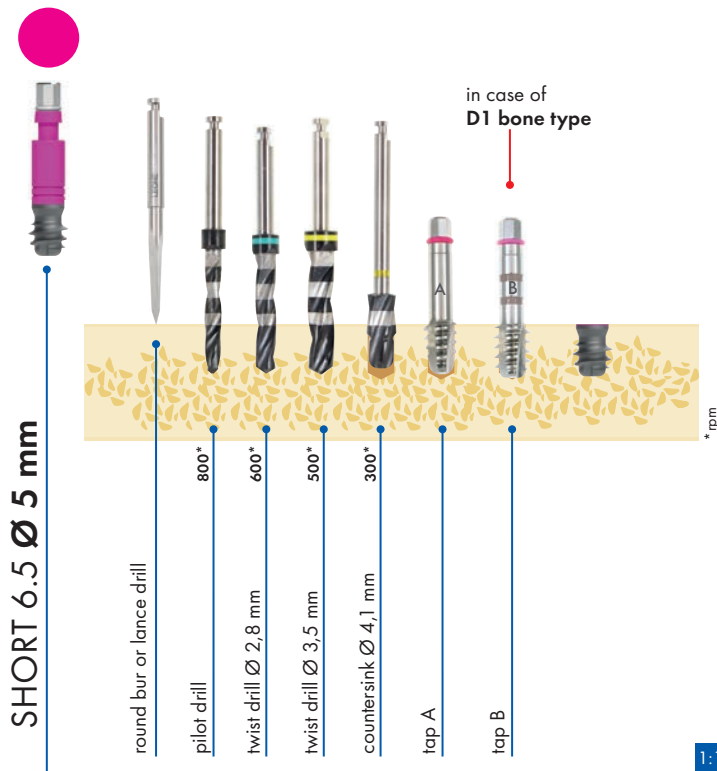

PRIOR TO PLACING A 6.5 SHORT IMPLANT:

- it is always necessary to use the tap "A" until the tap's threaded portion is totally inside the bone.

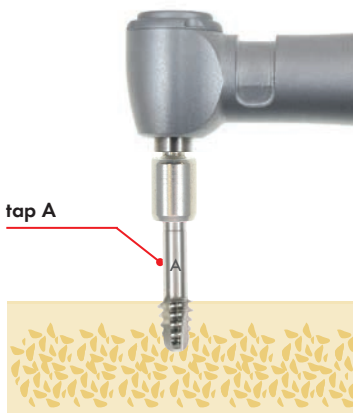

HIGH BONE DENSITY - D1 BONE TYPE:

- the use of tap "B" is necessary after tapping with bone tap "A". Use also tap "B" until the tap's threaded portion is totally inside the bone; tap "B" is easy distinguishable by the two marks on the shank.

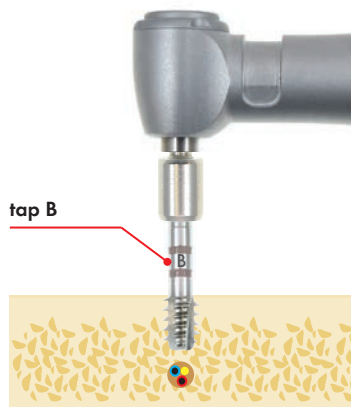

FOR BETTER MAINTENANCE OF IMPLANT SITE AXIS:

- the use of the handpiece for tapping and insertion of 6.5 Short implant is recommended.



1. PREPARATION OF THE IMPLANT SITE: STEP-BY-STEP

Illustrative protocol for **Classix Ø 4.1 L 10 mm implant**

NOTE:

- the use of the drills must be accompanied by adequate irrigation;
- in case of a subcrestal implant placement, take into account the planned level of implant placement when calculating the drilling depth.

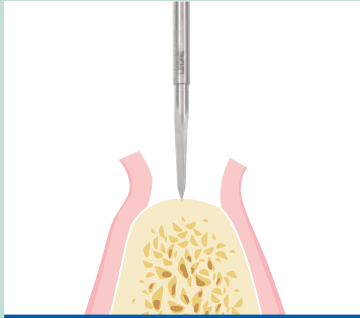

- Use the lance drill or round bur to mark the cortical bone for the subsequent drills.

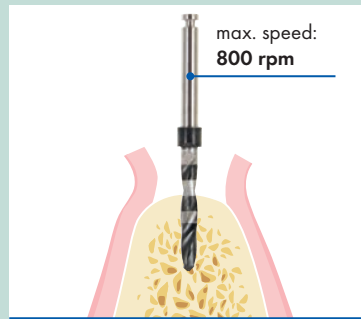

- Use the pilot drill up to the depth mark corresponding to the length of the selected implant.

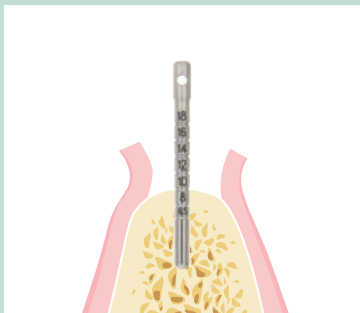

- Check the depth of the implant site with the depth gauge.

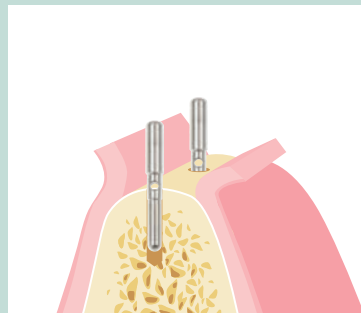

- Check parallelism with natural teeth and/or other adjacent implant sites with the paralleling pin. The paralleling pin can also be utilized after the application of the Ø 2,8 mm twist drill, taking care to seat the larger diameter in the implant site.

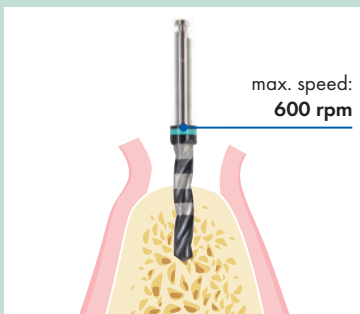

- Widen the diameter of the implant site with drills of increasing diameter. The drills have to be used up to the depth mark corresponding to the length of the selected implant.

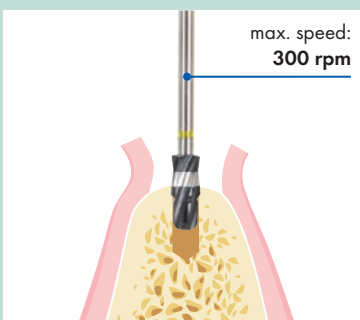
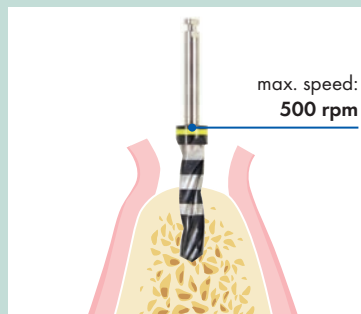

- Use the countersink to shape the osteotomy for the flared coronal portion of the implant.

IN CASE OF HIGH BONE DENSITY

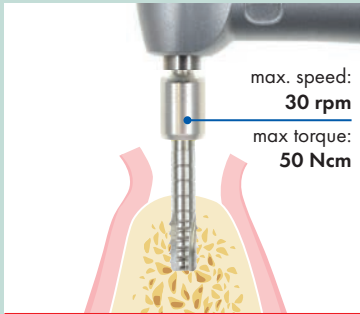

- In case of high bone density (D1 bone type), the use of the tap is recommended.

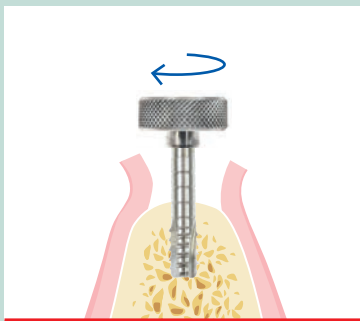

The tap can be connected either to the surgical hand screwdriver or to the handpiece.

If there is not enough space for a direct connection between the tap and the instruments, the extension for instruments may be used.

For use with a handpiece, connect the tap to the special adapter and set the micromotor to a max speed of 30 rpm and a max torque value of 50 Ncm.

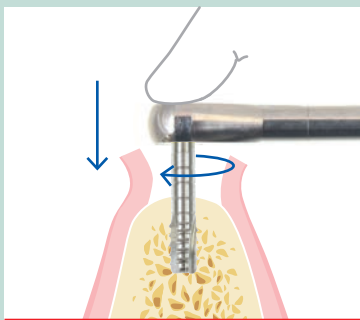

- Use the ratchet if the maximum torque value is not enough to complete tapping.

2. PLACEMENT OF THE IMPLANT: STEP-BY-STEP

Illustrative protocol for **Classix Ø 4.1 L 10 mm implant**

NOTE:

- the Classix implant can be screwed in with the help of the handpiece or of the surgical hand screwdriver; the use of the contra-angle handpiece ensures the maintenance of the implant site axis while driving the implant into the surgical cavity;
- insert the implant without irrigation.

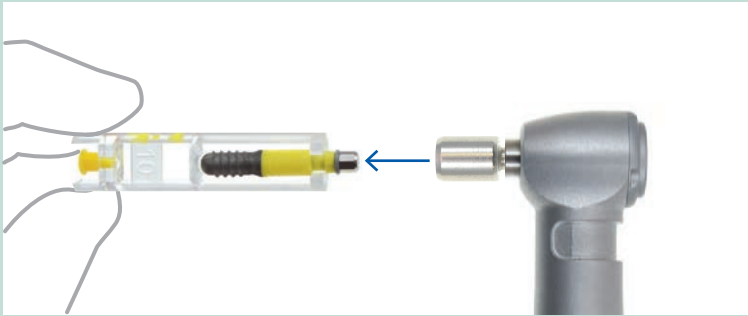

- Connect the handpiece adapter to the carrier of the implant and extract the implant from the holder. If there is not enough length with the carrier and adapter to reach the implant site, the extension for instruments may be used.

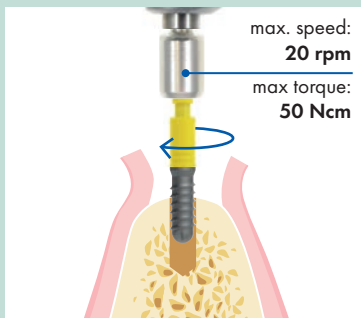
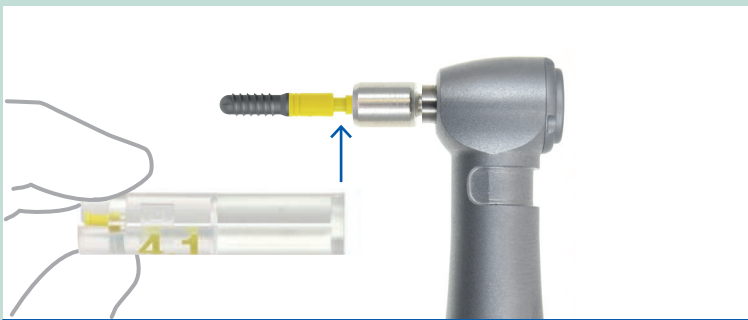

- Set a micromotor's maximum speed to 20 rpm and a max. torque value to 50 Ncm.
- Insert the implant up to the prepared level.

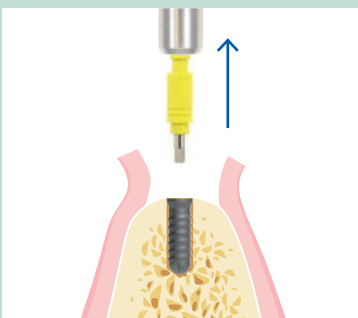

- Remove the carrier from the implant by pulling it out.

IF IMPLANT INSERTION IS DIFFICULT

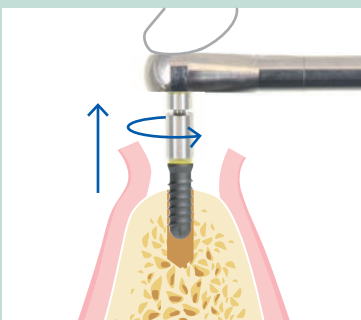
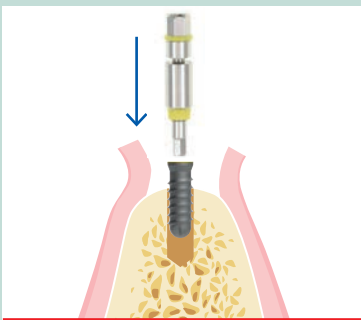
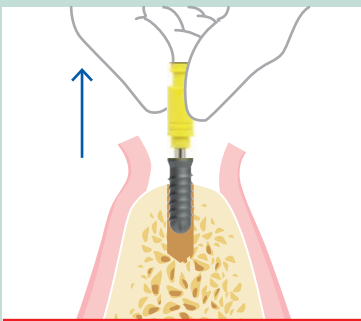
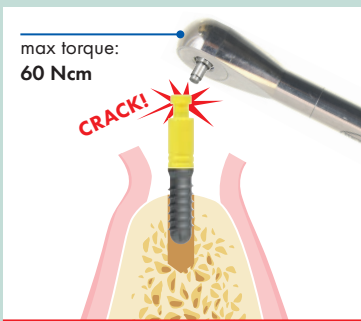
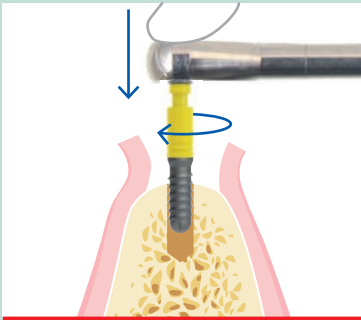

- If the pre-set maximum torque value is not sufficient to complete implant insertion, remove the handpiece adapter from the carrier and attach the ratchet. It is recommended to keep the instrument well aligned by keeping a finger on the head of the instrument, avoiding flexion.

- When using a ratchet, the forces exerted on the implant and the correspondent periimplant bone can become excessive. In this eventuality, should a value of 60 Ncm be exceeded, a torque limiting device makes the carrier break above the connection with the implant and then the carrier can be removed.

Note that carrier fracture is not always visible, but it is detectable by a sudden loss of functionality of the insertion instrument accompanied by a sharp crack.

- If fractured, remove the carrier.

- Replace the carrier with the High Torque driver for 3.0 connection which withstands torque values up to 160 Ncm.

- Attach the ratchet to the driver and remove the implant from the implant site.

- Tap the site and place the implant again.

3. HEALING OPTIONS

After implant placement, it is possible to choose among several healing options:

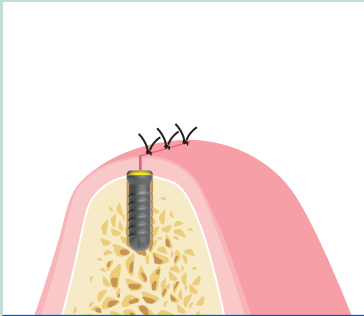

3.1

**TWO-STAGE TECHNIQUE
WITH COVER CAP**
supplied with the implant package

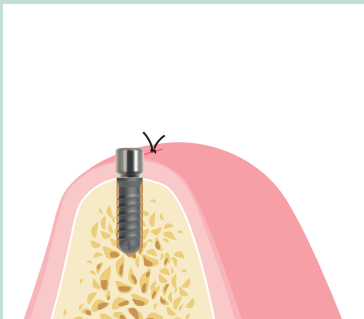

3.2

**ONE-STAGE TECHNIQUE
WITH HEALING CAP**

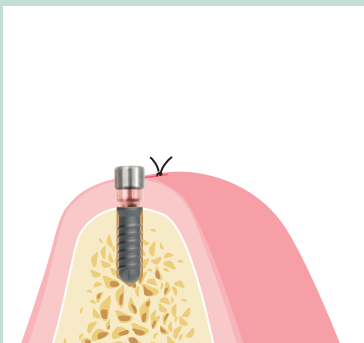

3.3

**TRANSGINGIVAL HEALING
WITH EXACONNECT PLUS**
(if a single-unit screw-retained restoration is planned)

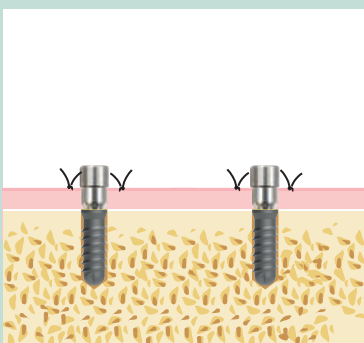

3.4

**TRANSGINGIVAL HEALING
WITH MUA PLUS**
(if a multi-unit screw-retained restoration is planned)



As an alternative, after a thorough evaluation by a clinical expert, it is possible to opt for an immediate loading procedure.

3.1 TWO-STAGE SURGICAL PROCEDURE: FIRST STAGE

NOTE:

- if you have planned a subcrestal implant placement, use a GH 1.5 healing cap instead of the cover cap included in the implant package, to avoid bone growth on the cap.

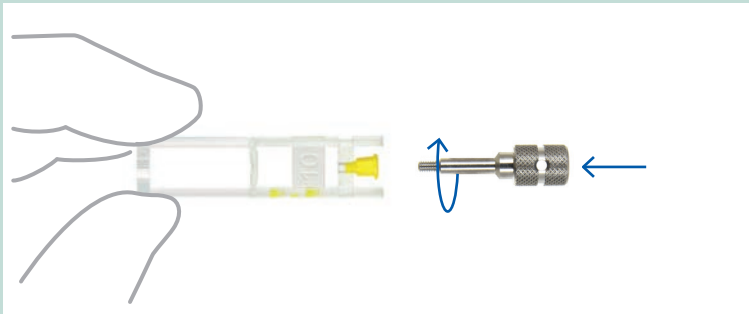

- Take the holder that previously contained the implant.

- Screw the instrument for cover caps onto the head of the cover cap.

Remove the biopolymer cover cap from the holder with a gentle extraction.

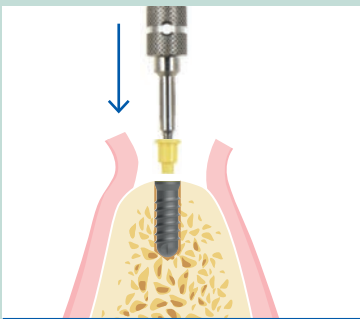
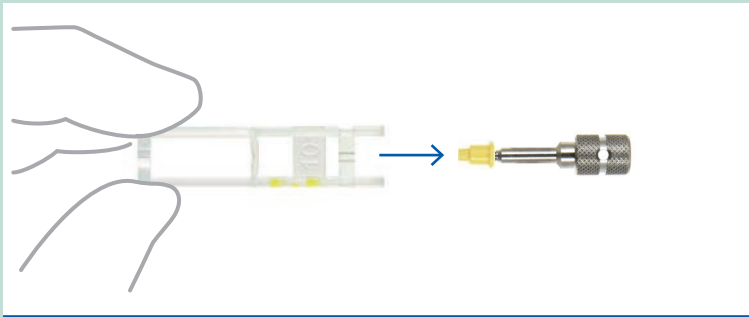

- After rinsing and drying of the inner part of the implant, insert the cap into the implant and press down.

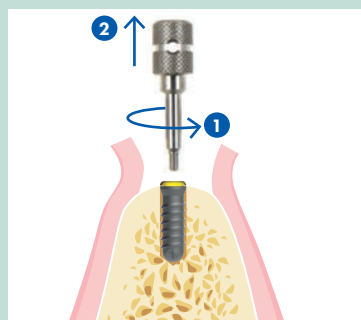

- Unscrew the instrument for cover caps.

- Press on the cap with a blunt instrument to make sure it is pushed all the way down.

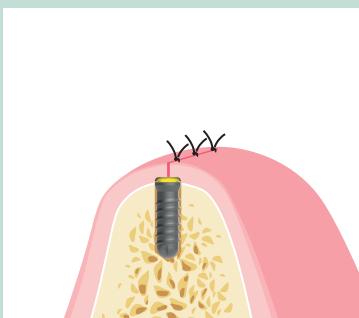

- The soft tissue is sutured over the implant.

3.1 TWO-STAGE SURGICAL PROCEDURE: SECOND STAGE

NOTE:

- select the healing cap according to the connection diameter (\varnothing 2,2 mm green, \varnothing 3,0 mm yellow), the gingival thickness and the prosthetic platform diameter.

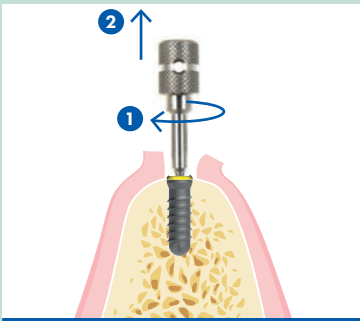

- Once osseointegration has occurred, make an incision to expose the implant and remove the cover cap with the specific instrument for cover caps.
- Screw the instrument for cover caps onto the head of the cover cap and remove by pulling it out.
- Rinse and dry the inner part of the implant.

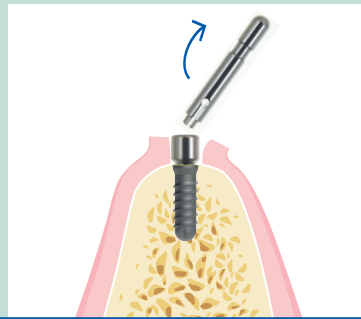
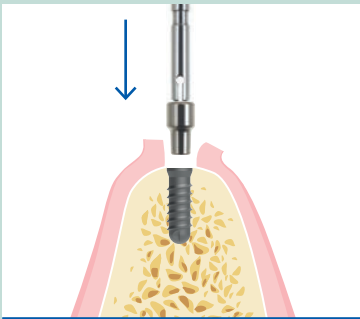

- Open the vial and extract the inner holder containing the sterile healing cap mounted on the carrier.
- Place the cap into the implant and exert a pressure on the carrier.
- Remove the carrier with a gentle side bending.

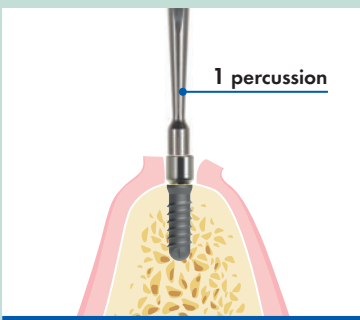

- Activate the locking-taper connection by applying a percussive force. We recommend to perform **1 percussion** with the specific abutment seater with titanium tip (with the abutment seater Double Force, use the HALF slot).

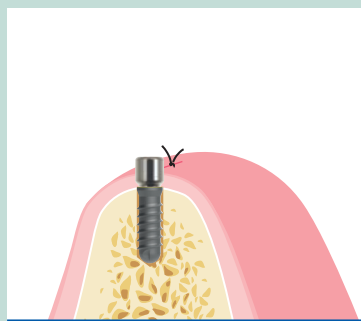

- Suture the soft tissues around the healing cap.

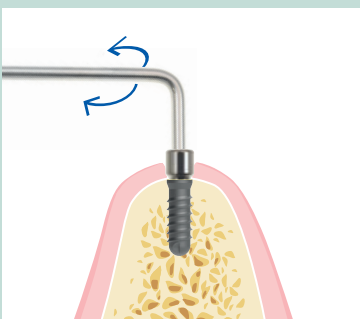

- When the healing process has occurred, unlock the healing cap by means of the specific hex head extractor.
- Seat the extractor into the hexagon on the head of the healing cap and rotate either clockwise or counter clockwise to unlock the healing cap.
- Use tweezers to remove the cap from the implant.

For impression taking and the fabrication of the prosthesis, refer to the "Prosthetic procedure" page 123

3.2 ONE-STAGE SURGICAL PROCEDURE

- NOTE:**
- select the healing cap according to the connection diameter (\varnothing 2,2 mm green, \varnothing 3,0 mm yellow), the gingival thickness and the prosthetic platform diameter of the abutment;
 - in case of flapless procedure and subcrestal implant placement, use Standard healing caps.

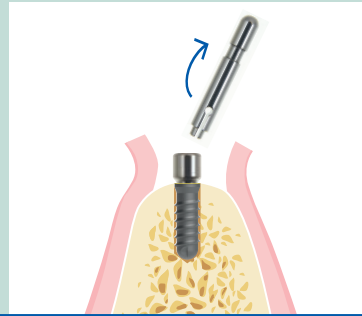
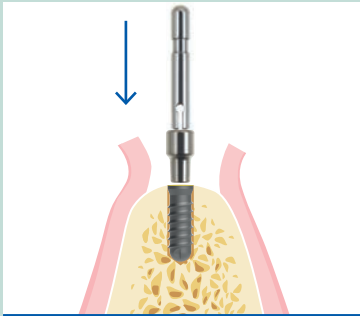

- Rinse and dry the inner part of the implant.
- Open the vial and extract the inner holder containing the sterile healing cap mounted on the carrier.
- Place the cap into the implant and exert a pressure on the carrier.
- Remove the carrier with a gentle side bending.

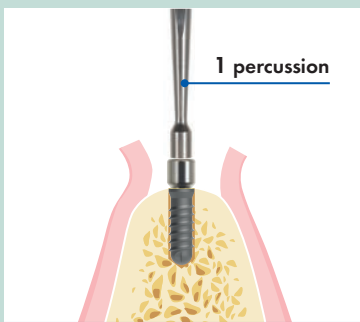

- Activate the locking-taper connection by applying a percussive force. We recommend to perform **1 percussion** with the specific abutment seater with titanium tip. (with the abutment seater Double Force, use the HALF slot).

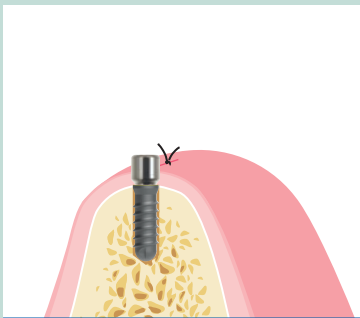

- Suture the soft tissues around the healing cap.

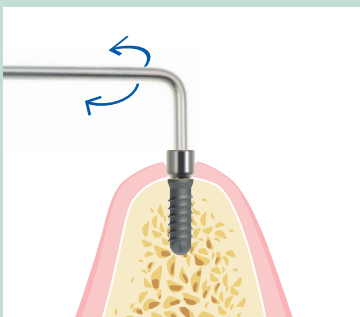

- When the osseointegration has occurred, unlock the healing cap by means of the specific hex head extractor.
- Seat the extractor into the hexagon on the head of the healing cap and rotate either clockwise or counter clockwise to unlock the healing cap.
 - Use tweezers to remove the cap from the implant.

For impression taking and the fabrication of the prosthesis, refer to the "Prosthetic procedure" page 123

3.3 TRANSGINGIVAL HEALING WITH EXACONNECT PLUS



NOTE:

- select the ExaConnect Plus according to the connection diameter (\varnothing 2,2 mm green, \varnothing 3,0 mm yellow);
- use the Abutment Gauges to choose the most suitable ExaConnect Plus in terms of GH and angulation;
- ExaConnect Plus with green connection (\varnothing 2,2 mm) has a \varnothing 4,1 mm prosthetic platform; therefore in case of >1 mm subcrestal implant placement use the \varnothing 4,5 mm Bone Profiler to allow the complete seating of the ExaConnect Plus.

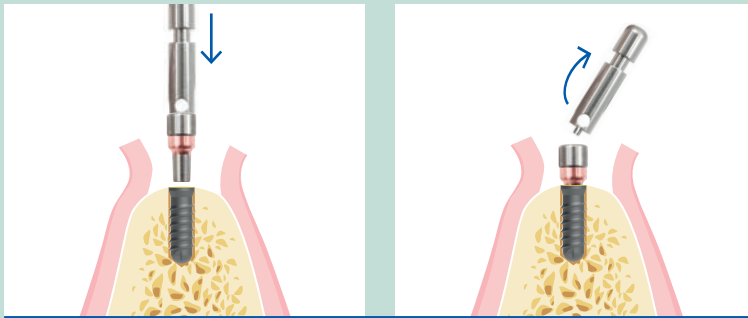

- Rinse and dry the inner part of the implant.
- Open the vial and extract the inner holder containing the sterile ExaConnect Plus with its healing screw mounted on the carrier.
- Place the ExaConnect Plus into the implant and rotate the connector to find the correct position.
- Exert a pressure on the carrier. Remove the carrier with a gentle side bending.

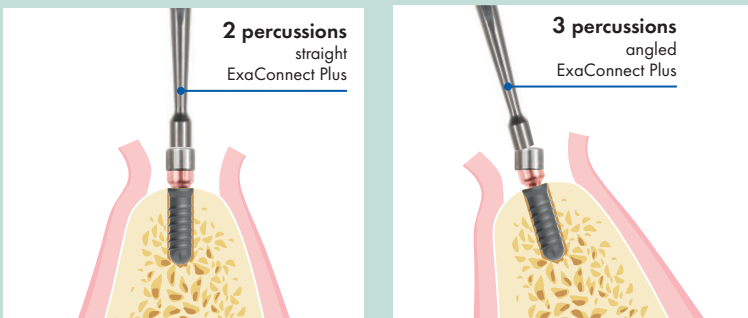

- Place the specific abutment seater with titanium tip on the healing screw pre-mounted on the ExaConnect Plus.
- In order to activate the locking-taper connection perform:
2 percussions onto the straight ExaConnect Plus
3 percussions onto the angled ExaConnect Plus
 (by aligning the instrument along the implant axis).

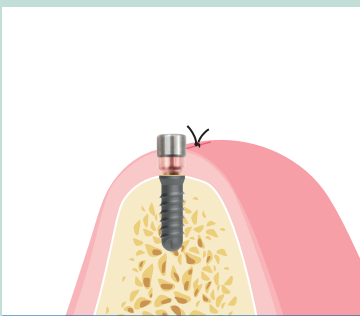

- Suture the soft tissues around the ExaConnect Plus.

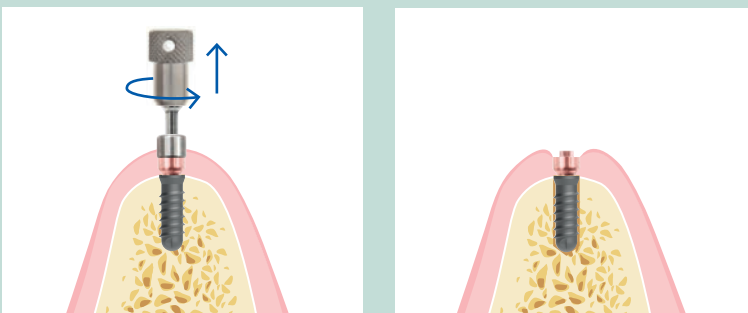

- When the osseointegration has occurred, unscrew the healing screw by means of the specific adapter for screws mounted on the prosthetic hand screwdriver.

The ExaConnect remains in place.
The impression taking and the restoration will be done on the ExaConnect.

For impression taking and the fabrication of the prosthesis, refer to the "Prosthetic procedure" page 123

3.4 TRANSGINGIVAL HEALING WITH MUA PLUS



NOTE:

- select the MUA Plus according to the connection diameter (Ø 2,2 mm green, Ø 3,0 mm yellow);
- use the Abutment Gauges to choose the most suitable MUA Plus in terms of GH and angulation.

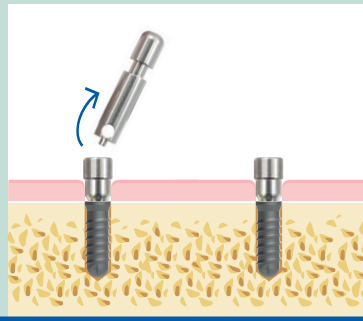
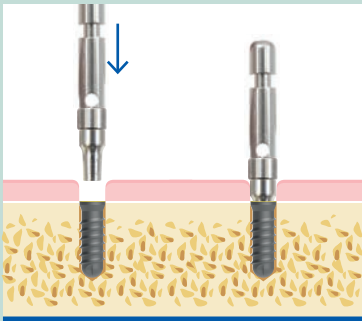

- Rinse and dry the inner part of the implant.
- Open the vial and extract the inner holder containing the sterile MUA Plus with its healing screw mounted on the carrier.
- Place the MUA Plus into the implant and rotate to find the correct position.
- Exert a pressure on the carrier.
Remove the carrier with a gentle side bending.

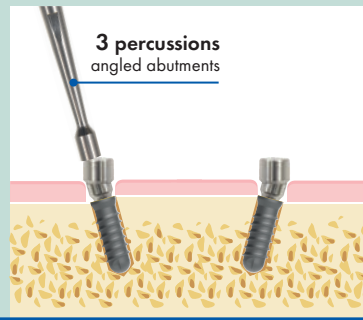
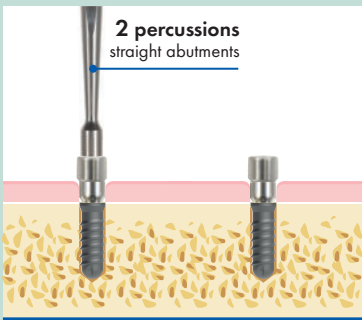

- Place the specific abutment seater with titanium tip on the healing screw pre-mounted on the MUA Plus.
- In order to activate the locking-taper connection perform,
2 percussions onto straight abutments
3 percussions onto angled abutments
(by aligning the instrument along the implant axis).

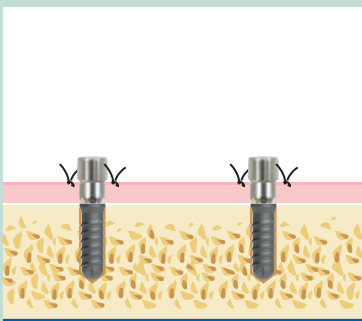

- Suture the soft tissues around the MUA Plus.

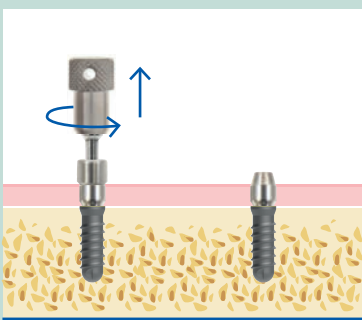

- When the osseointegration has occurred, unscrew the healing screw by means of the specific short adapter for screws mounted on the prosthetic hand screwdriver.
- The MUA remains in place.
The impression taking and the restoration will be done on the MUA.

For impression taking and the fabrication of the prosthesis, refer to the "Prosthetic procedure" page 123

IMPLANT SYSTEM

XCN[®]

PROSTHETIC PROCEDURE

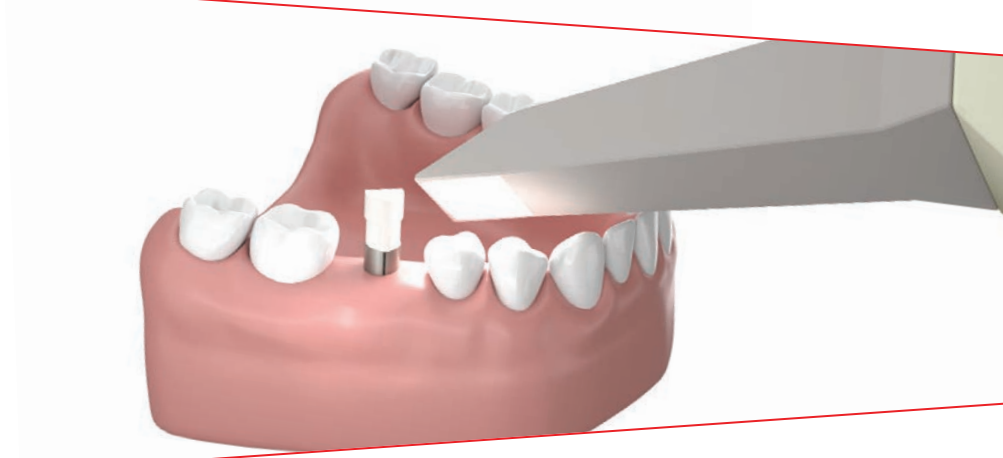

The pictures and illustrations in this brochure are for information purposes only and they are not intended to replace the methods or procedures for diagnosis and treatment planning of the Dental surgeon, Dentist and Dental Technician regarding the needs of each patient. Leone Spa disclaims any liability or any other obligation expressed or implied in this brochure.

DISCLAIMER

The Prosthetic Procedure and the use of the products of the XCN® Leone Implant System described in the following pages are intended for Professionals experienced in dental implant techniques.

In case of lack of basic notions, we suggest to attend specific courses in order to reach a high level of knowledge and practice in the use of implants. The rules on the use of the products described below represent a group of standard instructions that must be adjusted to the single needs and to the particular situations that may occur according to the manual ability, to the experience and to the diagnosis made by the legally qualified medical operator. It is not ascribed to the manufacturer the duty of monitoring the procedures of use of the product. A correct and appropriate use of the instruments and products related to the XCN® Leone Implant System shall completely be reverted to the clinician. The surgical procedure hereunder described is merely indicative as any single treatment case is assigned to the experience of the operator. As every medical operator well knows, a correct procedure and a perfect manufacture of the prosthesis may sometimes be followed by not satisfactory results owing to particular situations not imputable to responsibility of the dental operator or the manufacturer.

PREMISE

The Leone implant system offers the ability to fabricate fixed cement-and screw-retained prostheses, fixed and removable conometric-retained prostheses as well as bar-and attachment-retained prostheses. The following pages describe the prosthetic workflow step-by-step for every single indication. For a detailed description of each step, please refer to the online version of the prosthetic procedure and to the associated video tutorials: www.leone.it/english/implantology/video/procedure.php



		CONVENTIONAL WORKFLOW	DIGITAL WORKFLOW	
PAGES				
SINGLE CROWN	CEMENT-RETAINED	TEMPORARY ABUTMENT, STANDARD AND LARGE	125 138, 139	
		BASIC ABUTMENT, STANDARD AND LARGE	125 138, 139	
		360° ANATOMICAL ABUTMENT, STANDARD AND LARGE	125 138, 139	
		MULTITECH ABUTMENT	125 137, 138, 139	
		TI-BASE ABUTMENT	125 136, 137	
	SCREW-RETAINED	EXACONNECT	126, 127 140, 141, 142, 143	
	FIXED BRIDGE FIXED FULL-ARCH PROSTHESIS	CEMENT-RETAINED	TEMPORARY ABUTMENT, STANDARD AND LARGE	128 138, 139
			BASIC ABUTMENT, STANDARD AND LARGE	128 138, 139
			360° ANATOMICAL ABUTMENT, STANDARD AND LARGE	128 138, 139
			MULTITECH ABUTMENT	128 138, 139
SCREW-RETAINED		MUA	129, 130 144, 145, 146	
REMOVABLE PROSTHESIS	CONOMETRIC-RETAINED	MUA-CONIC	132, 133 147, 148, 149	
		Fixed CAP	132, 133 147, 148, 149	
		Light CAP	132, 133 147, 148, 149	
		Weld CAP	131	
REMOVABLE PROSTHESIS	BAR-RETAINED	MUA	129 144, 145, 146	
		ATTACHMENT-RETAINED	BALL HEAD ABUTMENT	HOUSING WITH O-RING 134 HOUSING WITH INSERT 134 MICRO HOUSING WITH O-RING 134
	CONOMETRIC-RETAINED	MUA-CONIC	Mobile CAP	135
			Light CAP	135

NOTE: the patient should be given appropriate post-operative instructions in order to prevent complications and variations in the efficiency of the device; a good level of oral hygiene and periodical checkups are recommended.

The Prosthetic Procedure reported was conceived with the invaluable contribution of Dental Technician Mr. Massimiliano Pisa, whom we thank sincerely.

CONVENTIONAL PROSTHETIC PROCEDURE

CEMENT-RETAINED SINGLE CROWN

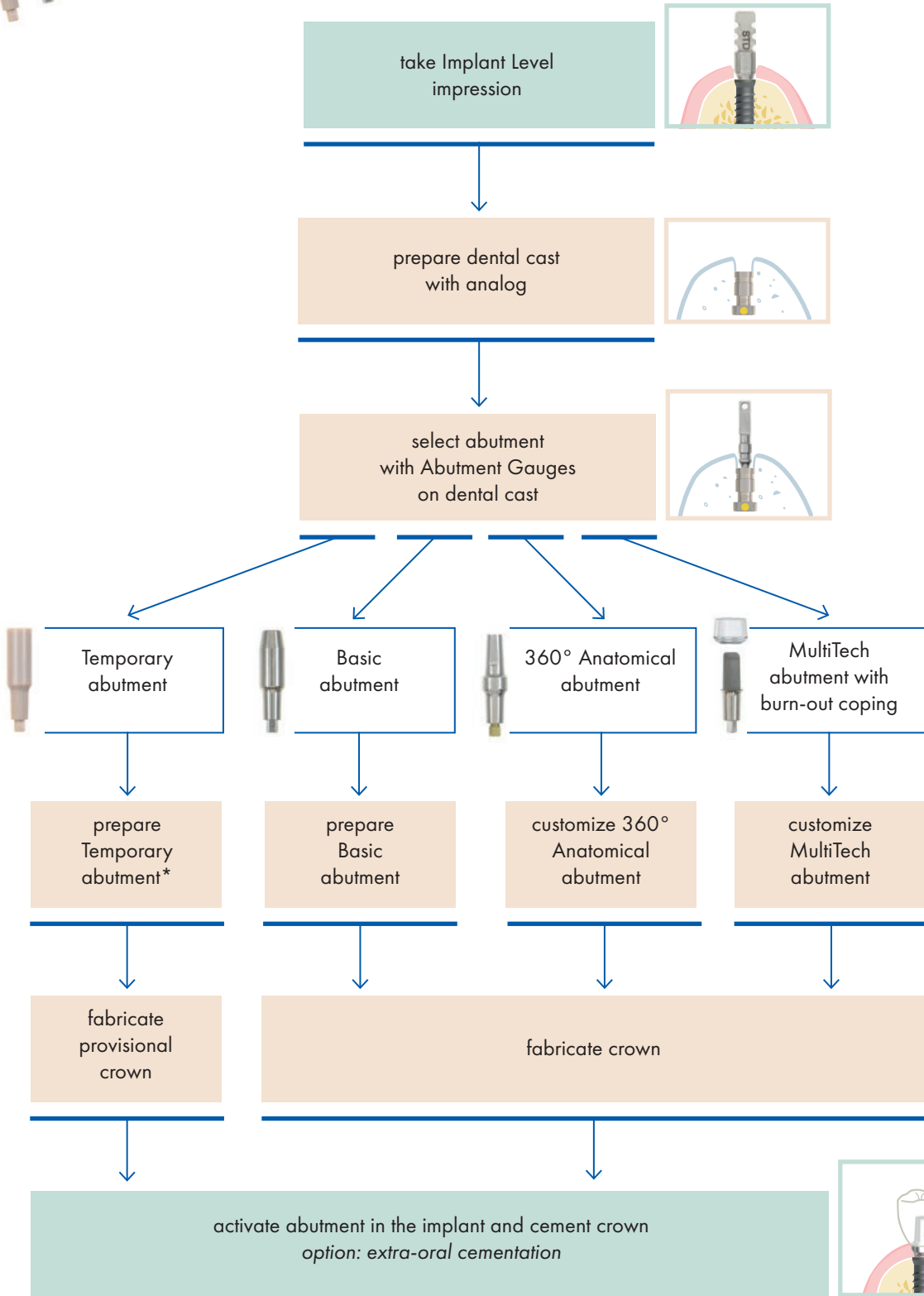

*The Temporary abutment and the provisional crown may also be selected and fabricated in the dental office.

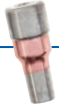

CONVENTIONAL PROSTHETIC WORKFLOW

SCREW-RETAINED SINGLE CROWN - ABUTMENT LEVEL

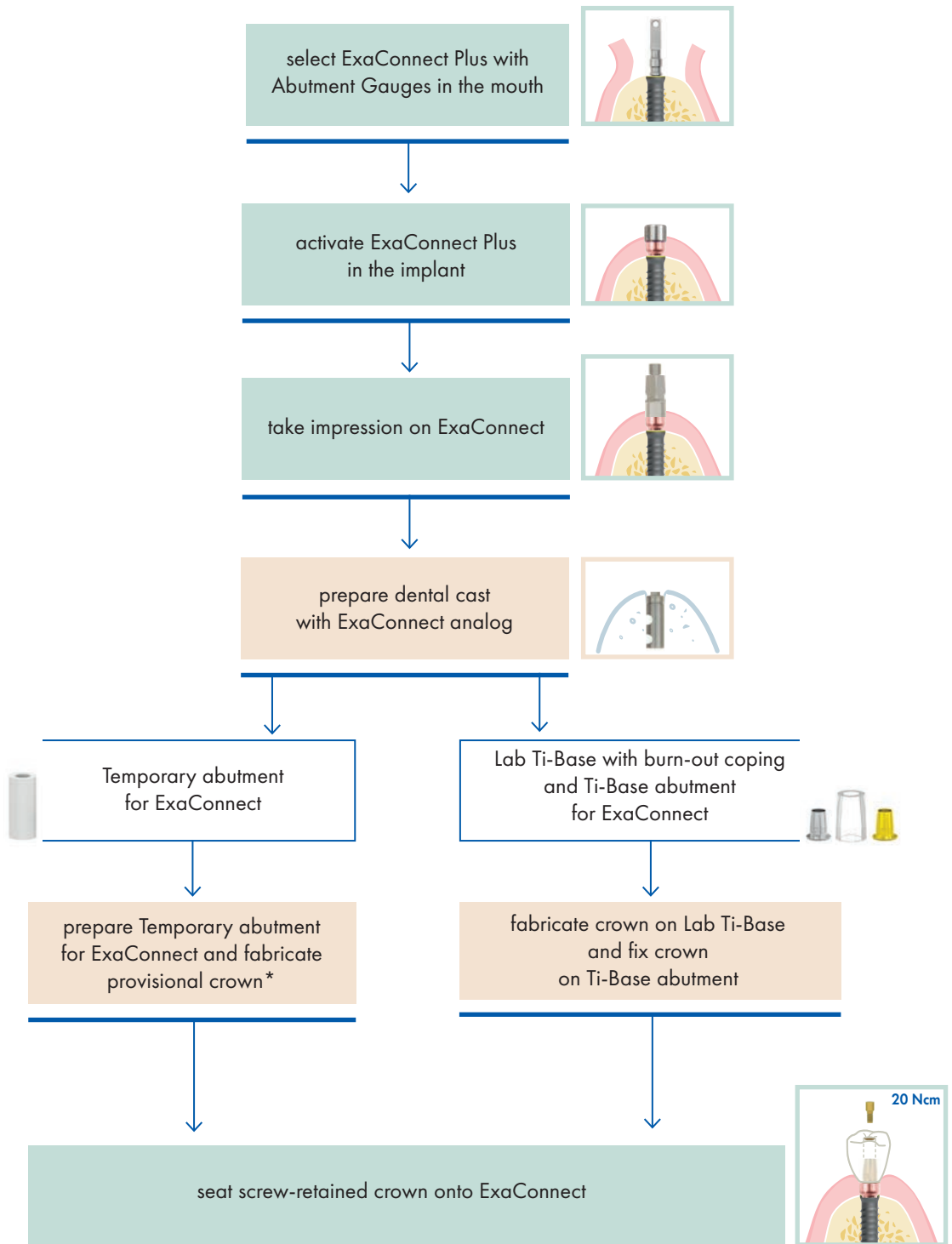

*The Temporary abutment and the provisional crown may also be fabricated in the dental office.

→ Steps carried out by **THE CLINICIAN**
→ Steps carried out by **THE DENTAL LABORATORY**

CONVENTIONAL PROSTHETIC WORKFLOW



SCREW-RETAINED SINGLE CROWN - IMPLANT LEVEL

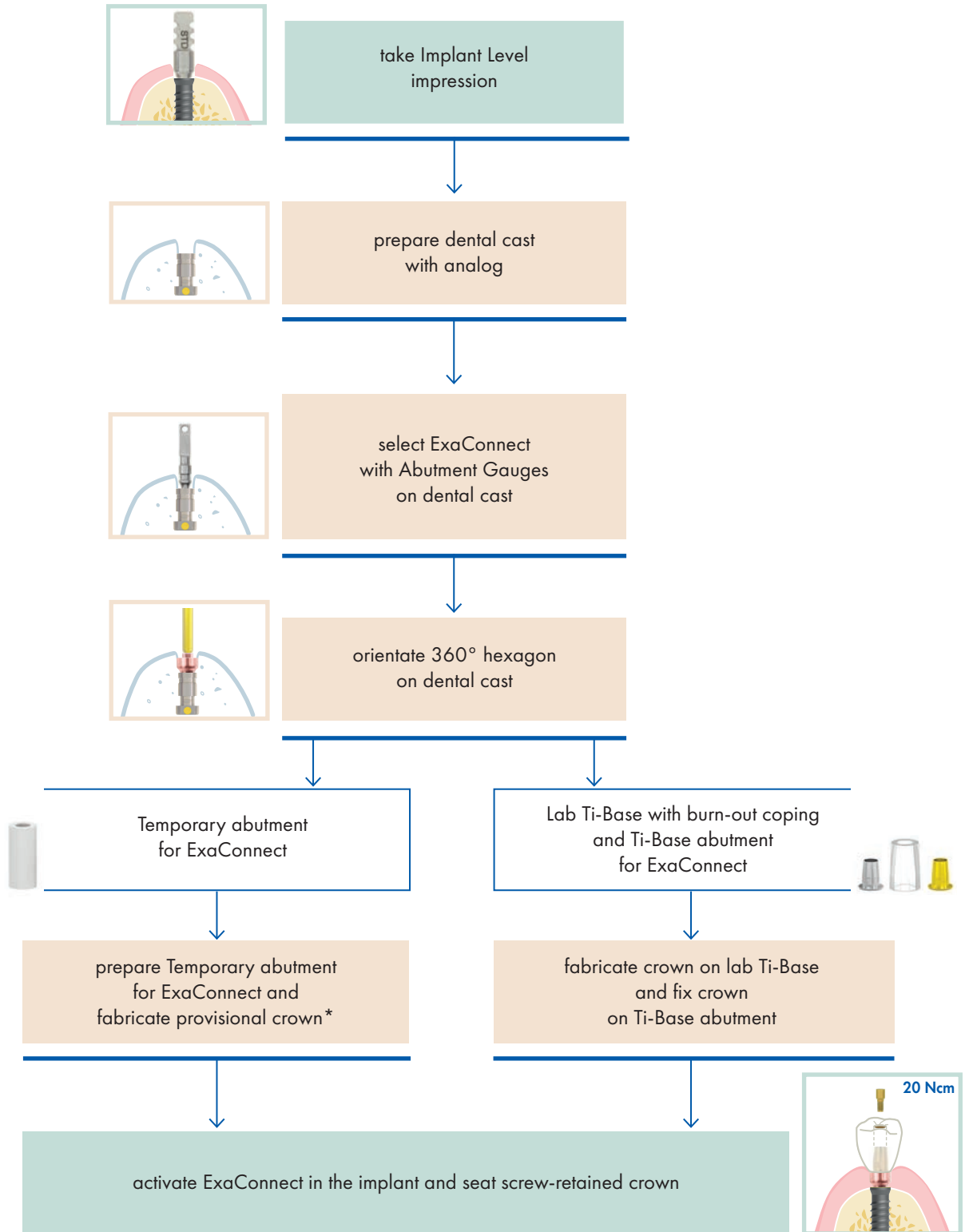

*The Temporary abutment and the provisional crown may also be fabricated in the dental office.

→ Steps carried out by **THE CLINICIAN**
→ Steps carried out by **THE DENTAL LABORATORY**

CONVENTIONAL PROSTHETIC WORKFLOW

CEMENT-RETAINED BRIDGE

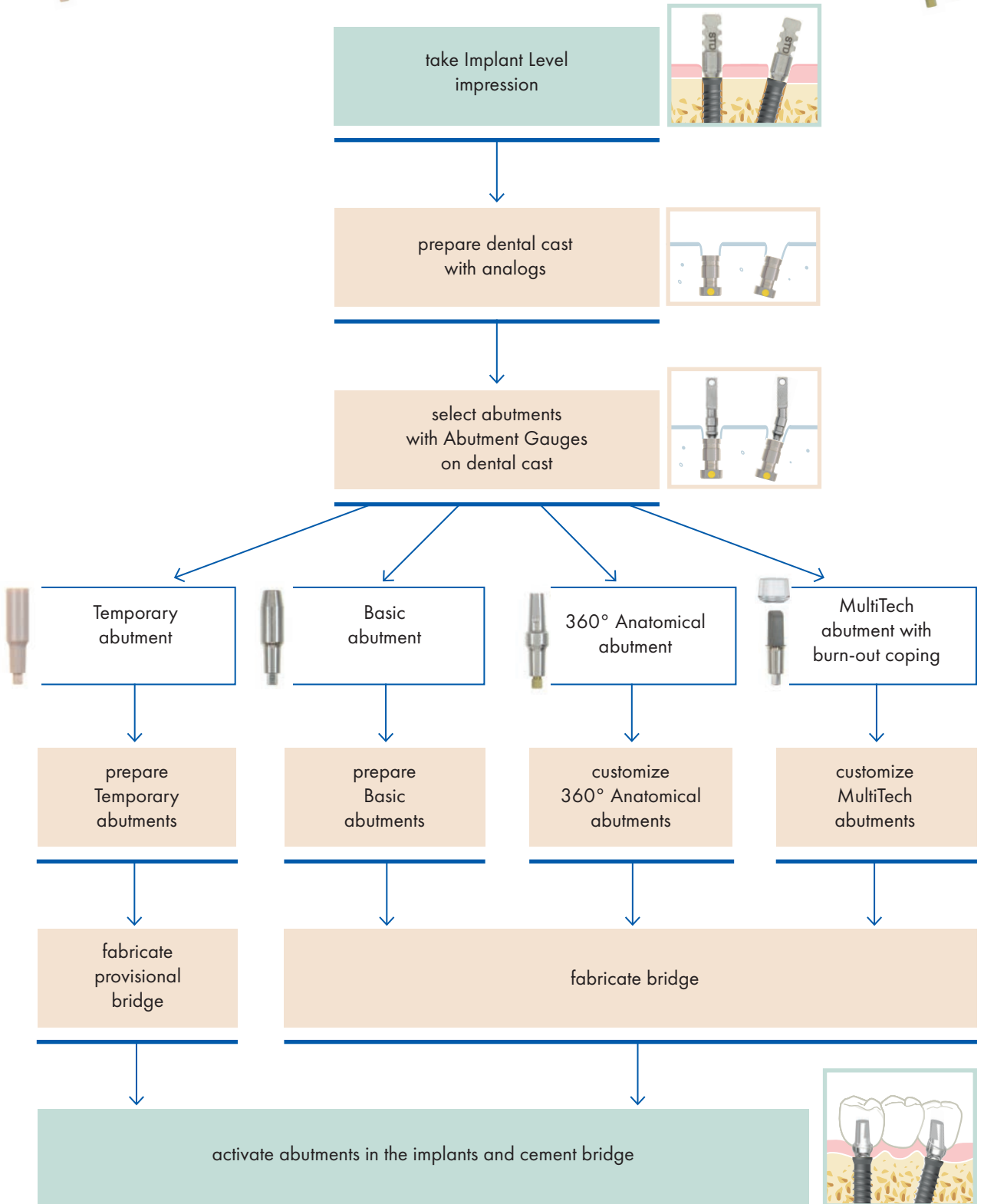

→ Steps carried out by **THE CLINICIAN**
→ Steps carried out by **THE DENTAL LABORATORY**

CONVENTIONAL PROSTHETIC WORKFLOW



SCREW-RETAINED BRIDGE/BAR

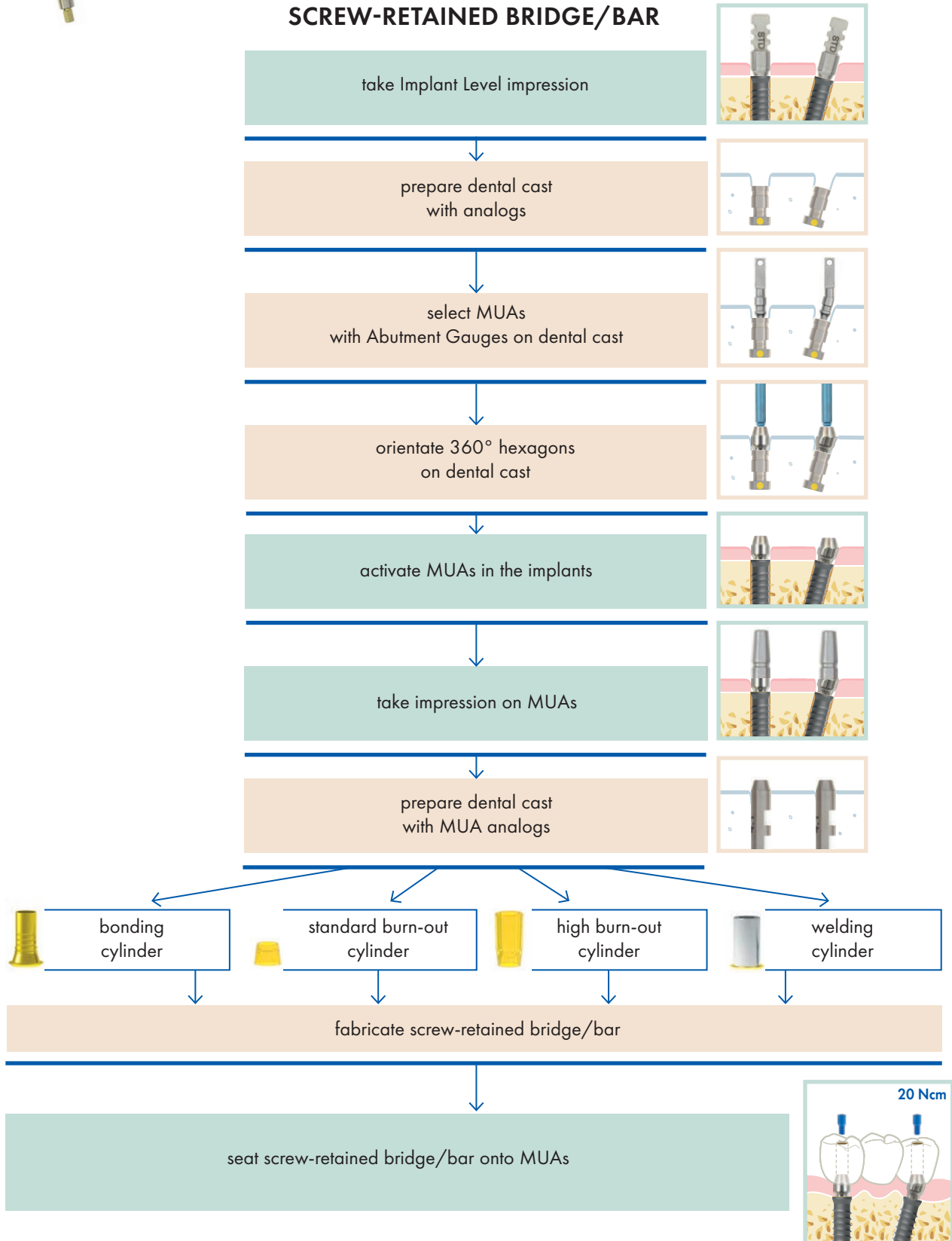

Steps carried out by **THE CLINICIAN** Steps carried out by **THE DENTAL LABORATORY**

CONVENTIONAL PROSTHETIC WORKFLOW



ALL-ON-FOUR IMMEDIATE LOADING

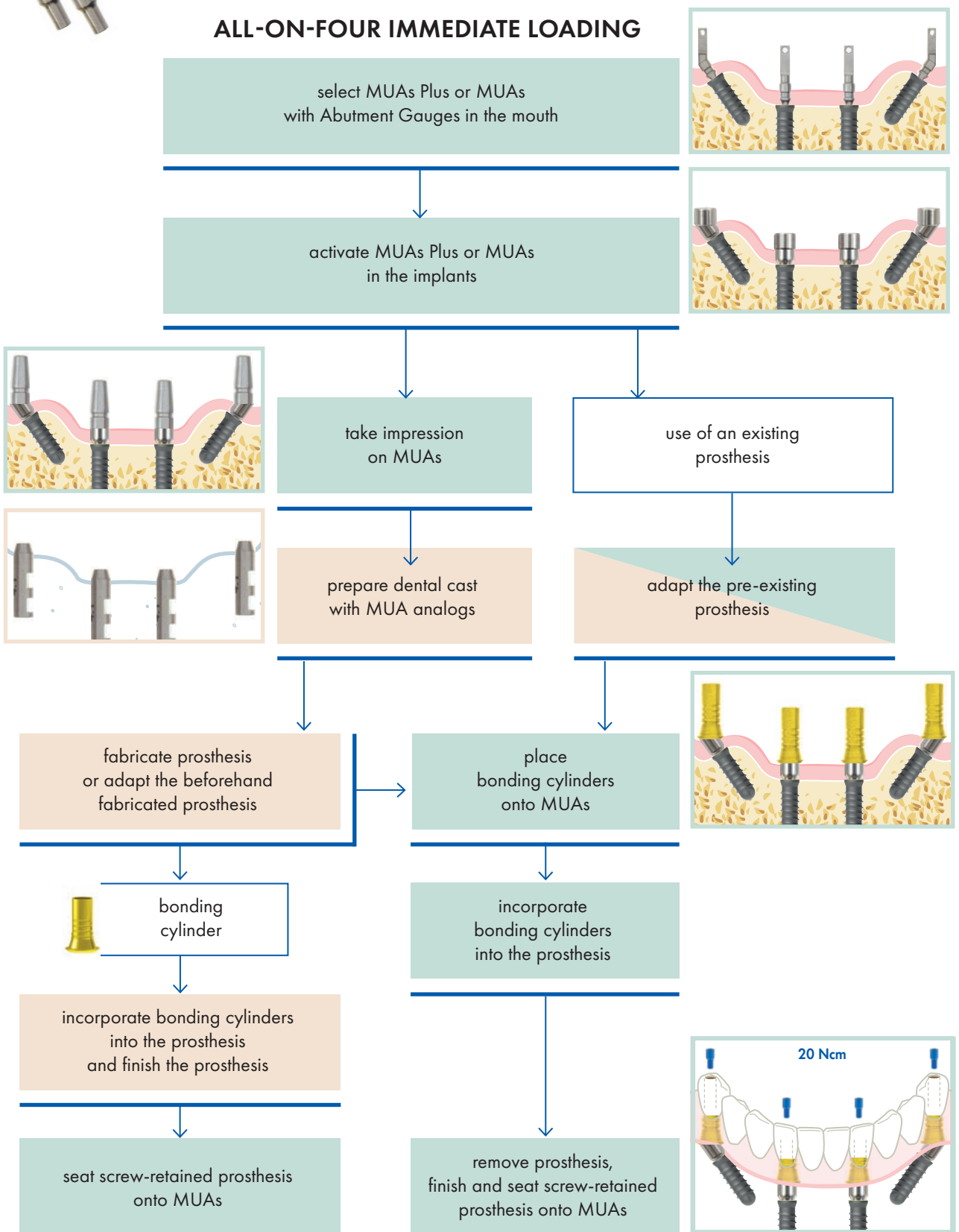

→ Steps carried out by **THE CLINICIAN**
→ Steps carried out by **THE DENTAL LABORATORY**

CONVENTIONAL PROSTHETIC WORKFLOW

**CONOMETRIC-RETAINED BRIDGE WITH WELD CAPS
IMMEDIATE LOADING**

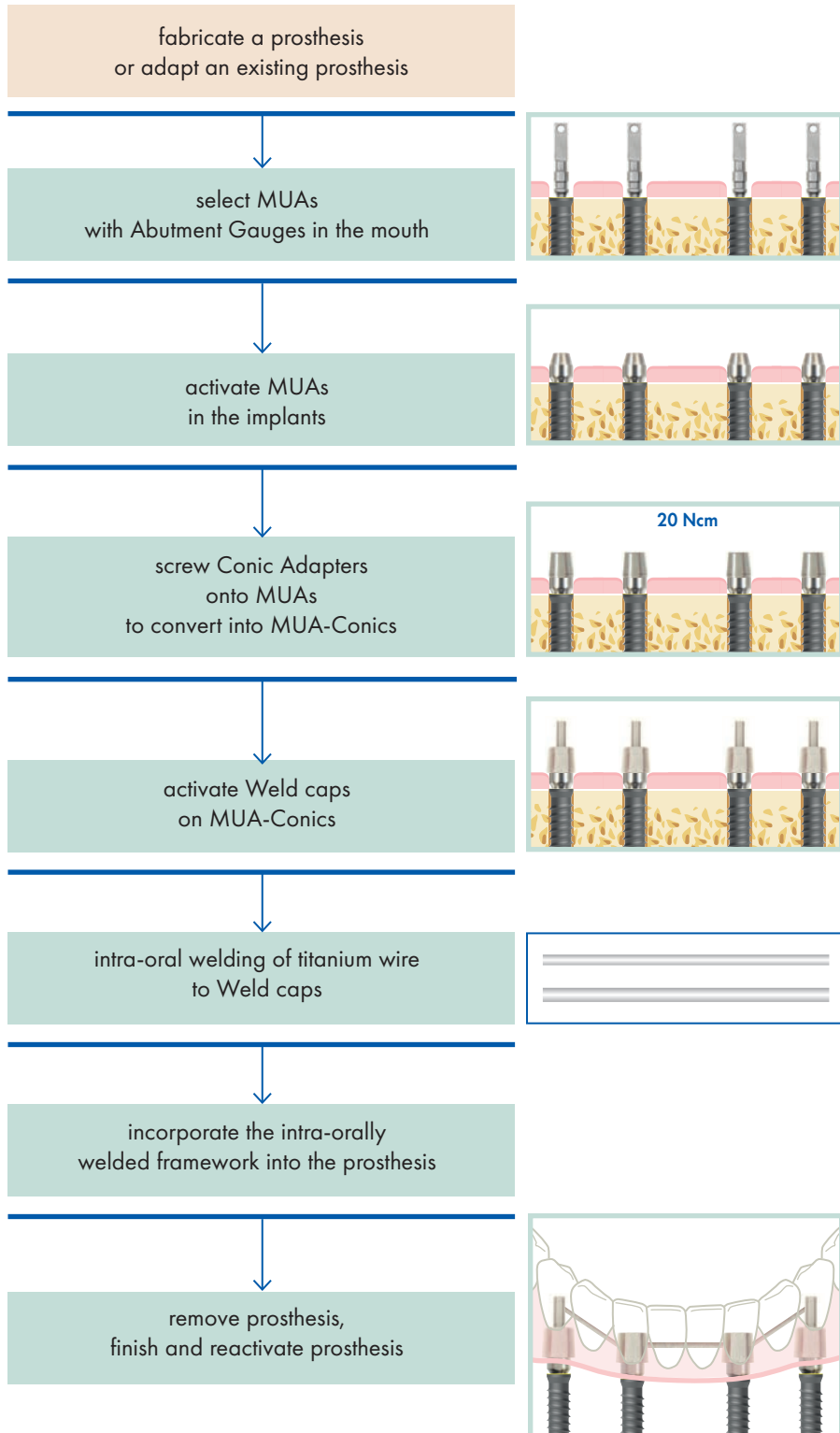

→ Steps carried out by **THE CLINICIAN**
→ Steps carried out by **THE DENTAL LABORATORY**

CONVENTIONAL PROSTHETIC WORKFLOW

CONOMETRIC-RETAINED BRIDGE WITH FIXED CAPS

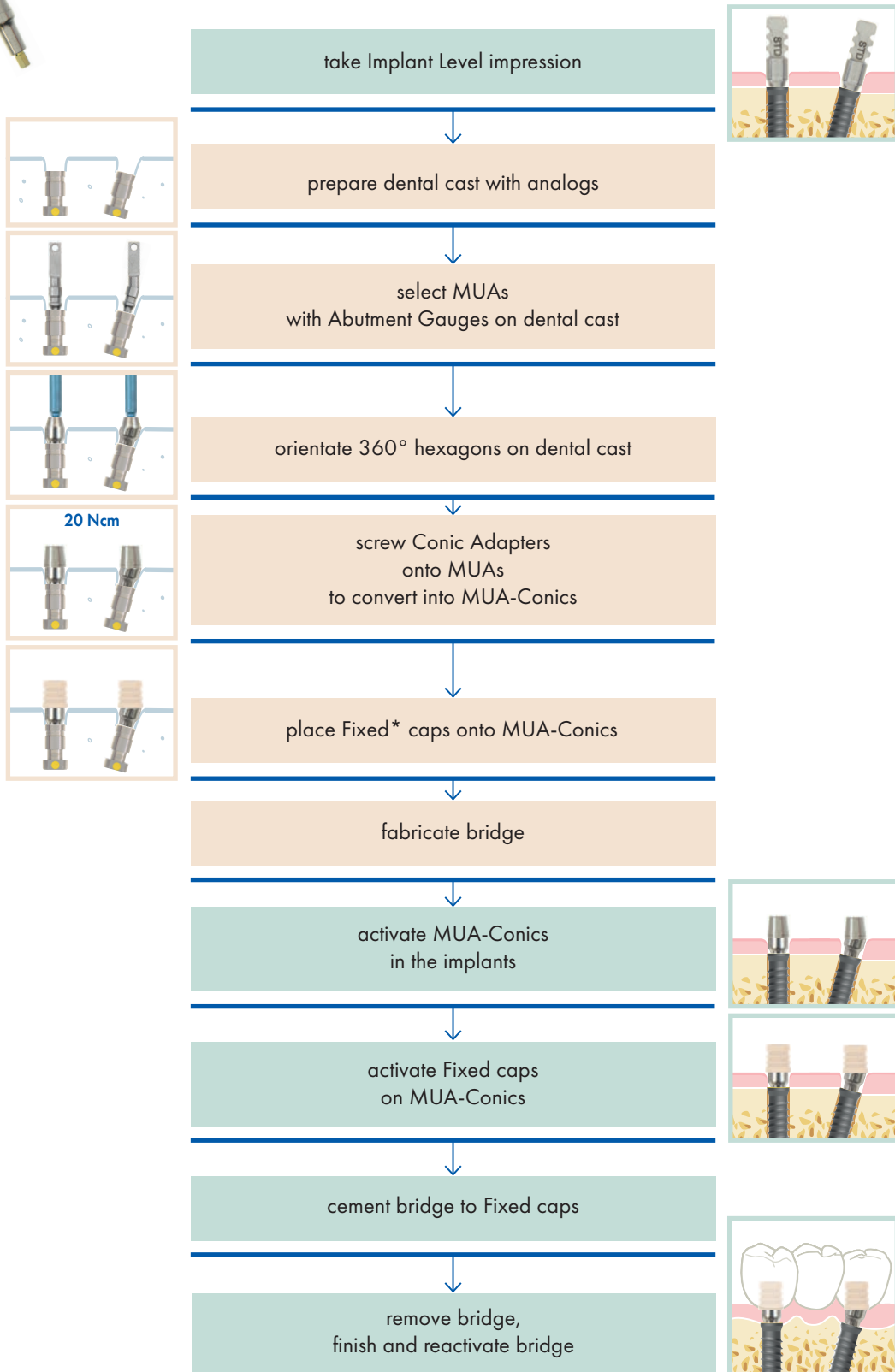

*It is possible to combine the use of the *Light cap* to modulate the retention of the prosthesis (see page 79)

→ Steps carried out by **THE CLINICIAN**
→ Steps carried out by **THE DENTAL LABORATORY**

CONVENTIONAL PROSTHETIC WORKFLOW

CONOMETRIC-RETAINED FULL-ARCH WITH FIXED CAPS

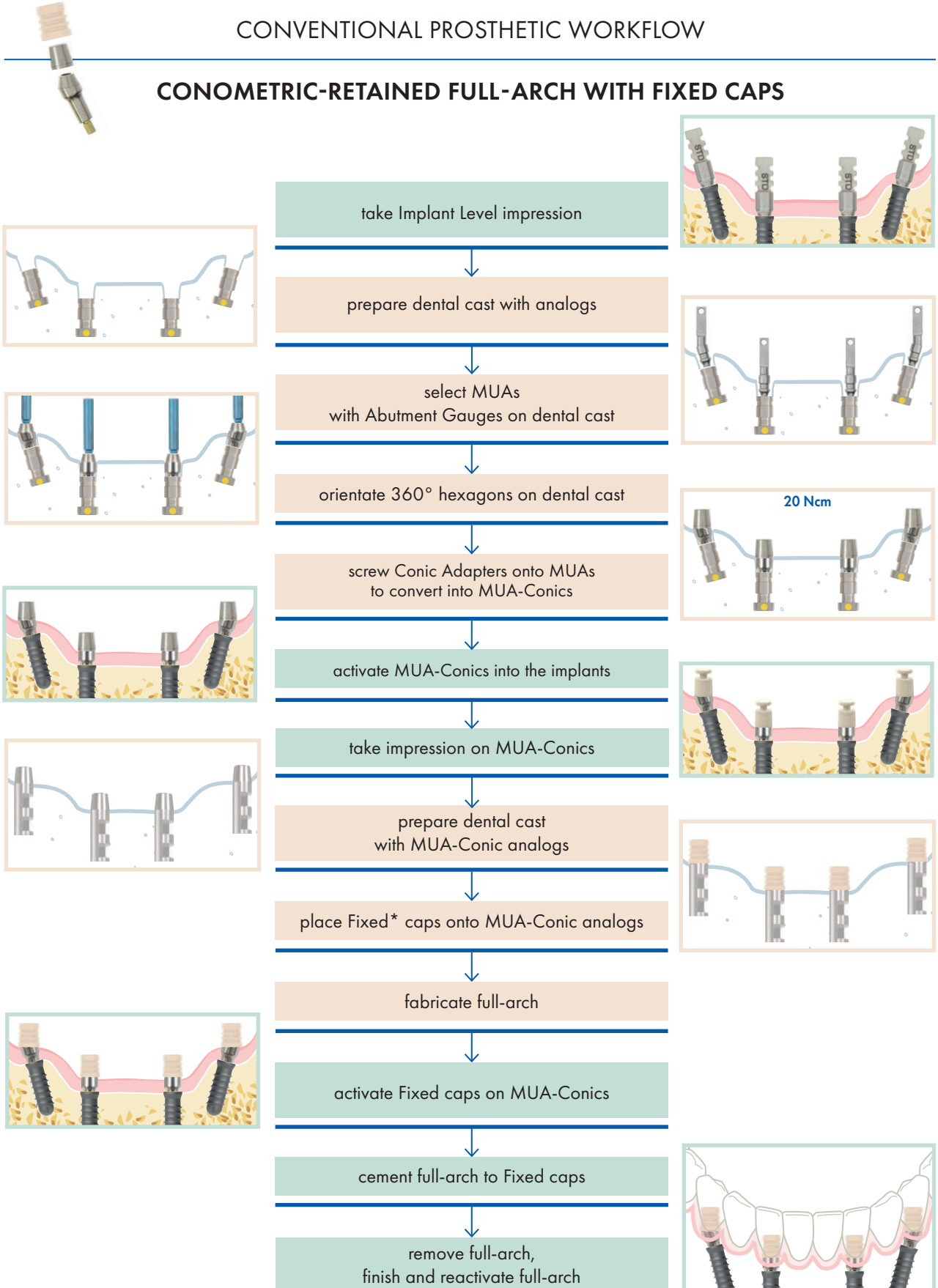

*It is possible to combine the use of the *Light* cap to modulate the retention of the prosthesis (see page 79)

→ Steps carried out by **THE CLINICIAN**
→ Steps carried out by **THE DENTAL LABORATORY**

CONVENTIONAL PROSTHETIC WORKFLOW



REMOVABLE PROSTHESIS ON BALL HEAD ABUTMENTS

take Implant Level impression

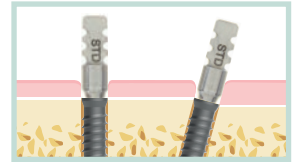

prepare dental cast with analogs



select ball head abutments with Abutment Gauges on dental cast

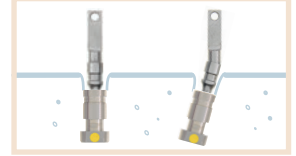

orientate 360° hexagons on dental cast

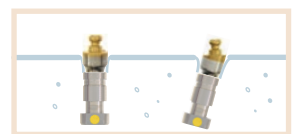

activate ball head abutments in the implants

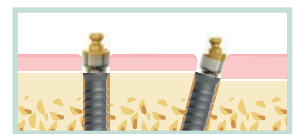

select housing type

housing with O-ring or micro housing with micro O-ring



housing with soft white, medium orange or rigid violet insert



take impression with housings placed on ball head abutments

fabricate overdenture with adequate space for abutments and housings

incorporate housings into the overdenture

remove overdenture, finish and deliver overdenture

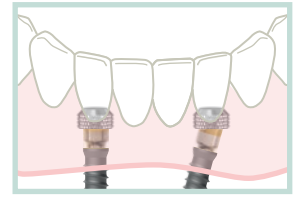

→ Steps carried out by **THE CLINICIAN**
→ Steps carried out by **THE DENTAL LABORATORY**

CONVENTIONAL PROSTHETIC WORKFLOW

REMOVABLE CONOMETRIC-RETAINED PROSTHESIS

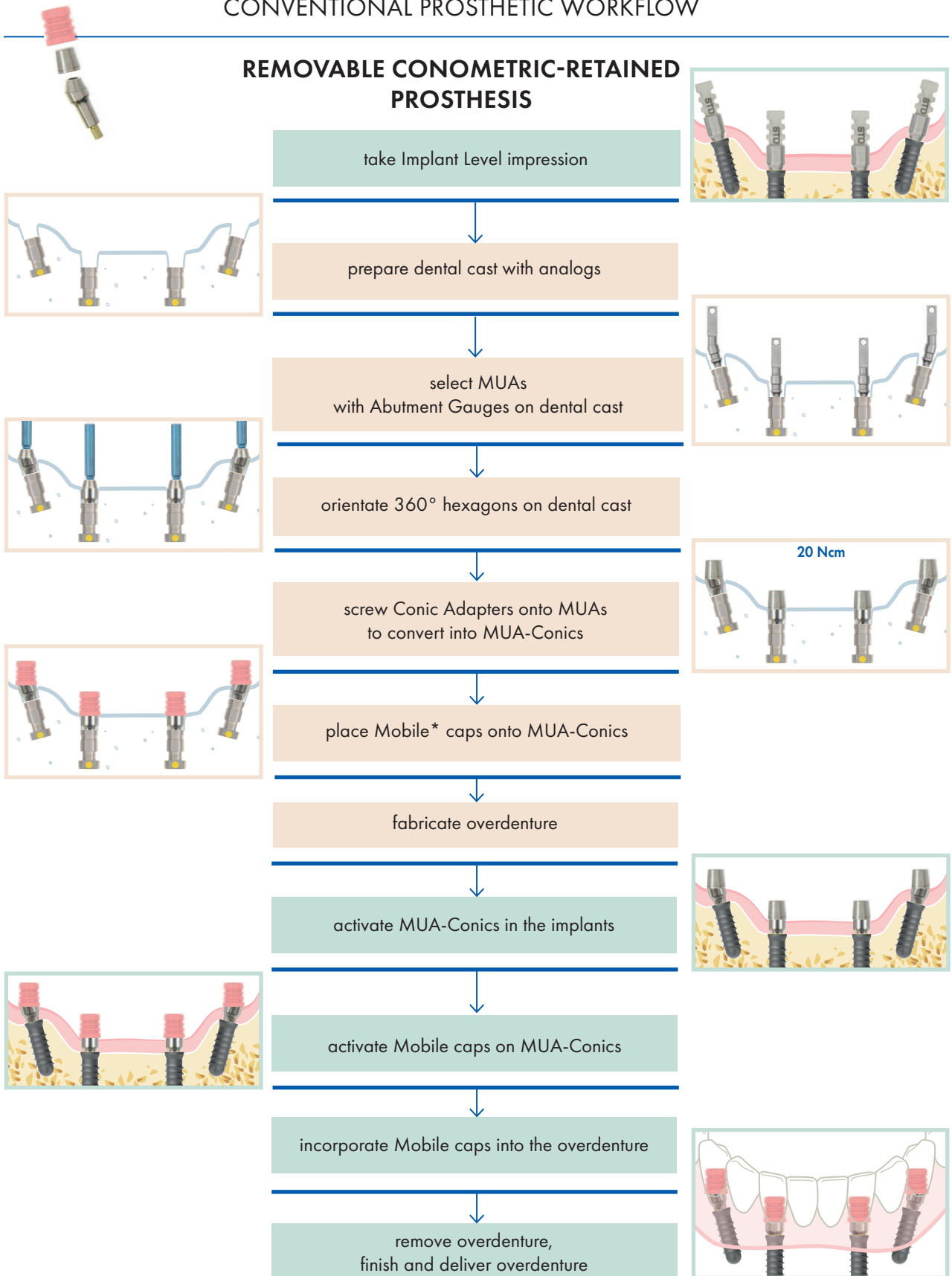

*It is possible to combine the use of the *Light* cap to modulate the retention of the prosthesis (see page 79)

→ Steps carried out by **THE CLINICIAN**
→ Steps carried out by **THE DENTAL LABORATORY**

DIGITAL PROSTHETIC WORKFLOW

CEMENT-RETAINED SINGLE CROWN

CHAIRSIDE TECHNIQUE

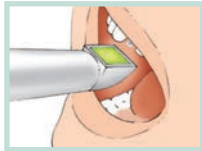

take digital intra-oral impression
at Implant Level*



select Ti-Base abutment**
design and mill the crown (CAD-CAM)

bond monolithic crown
to Ti-Base abutment



activate restoration in the implant

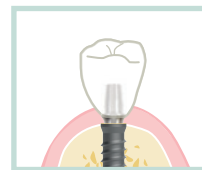

*Orientate the Scan Post so that the notch is on the buccal side.

**As to dental CAD-CAM software including the specified products, please refer to Leone web site www.leone.it under section Implantology and download any updated library.

→ Steps carried out by **THE CLINICIAN**
→ Steps carried out by **THE DENTAL LABORATORY**



DIGITAL PROSTHETIC WORKFLOW

CEMENT-RETAINED SINGLE CROWN
CONVENTIONAL IMPRESSION TAKING

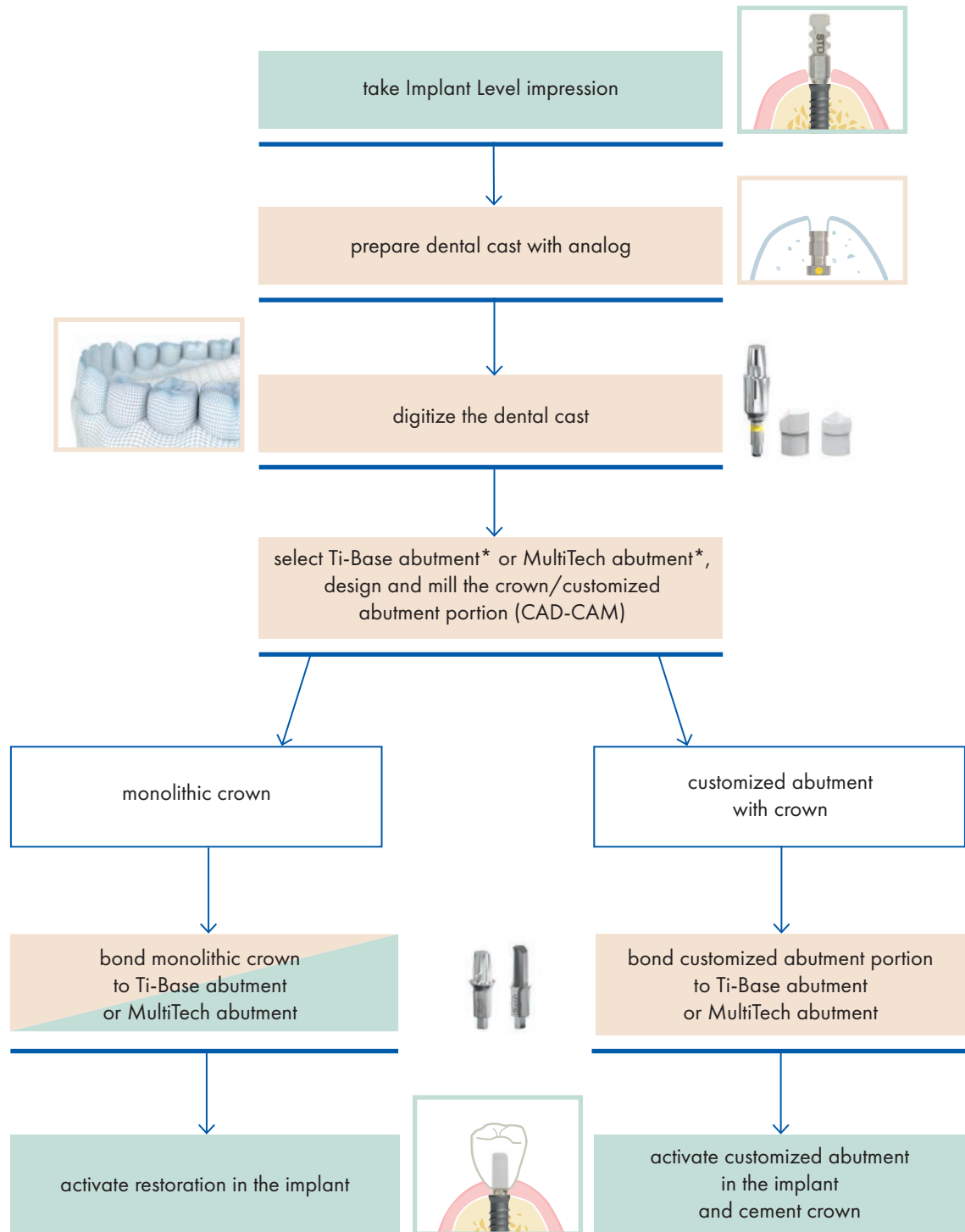

*As to dental CAD-CAM software including the specified products, please refer to Leone web site www.leone.it under section Implantology and download any updated library.

→ Steps carried out by **THE CLINICIAN**
→ Steps carried out by **THE DENTAL LABORATORY**

DIGITAL PROSTHETIC WORKFLOW

CEMENT-RETAINED BRIDGE/SINGLE CROWN

DIGITAL IMPRESSION TAKING

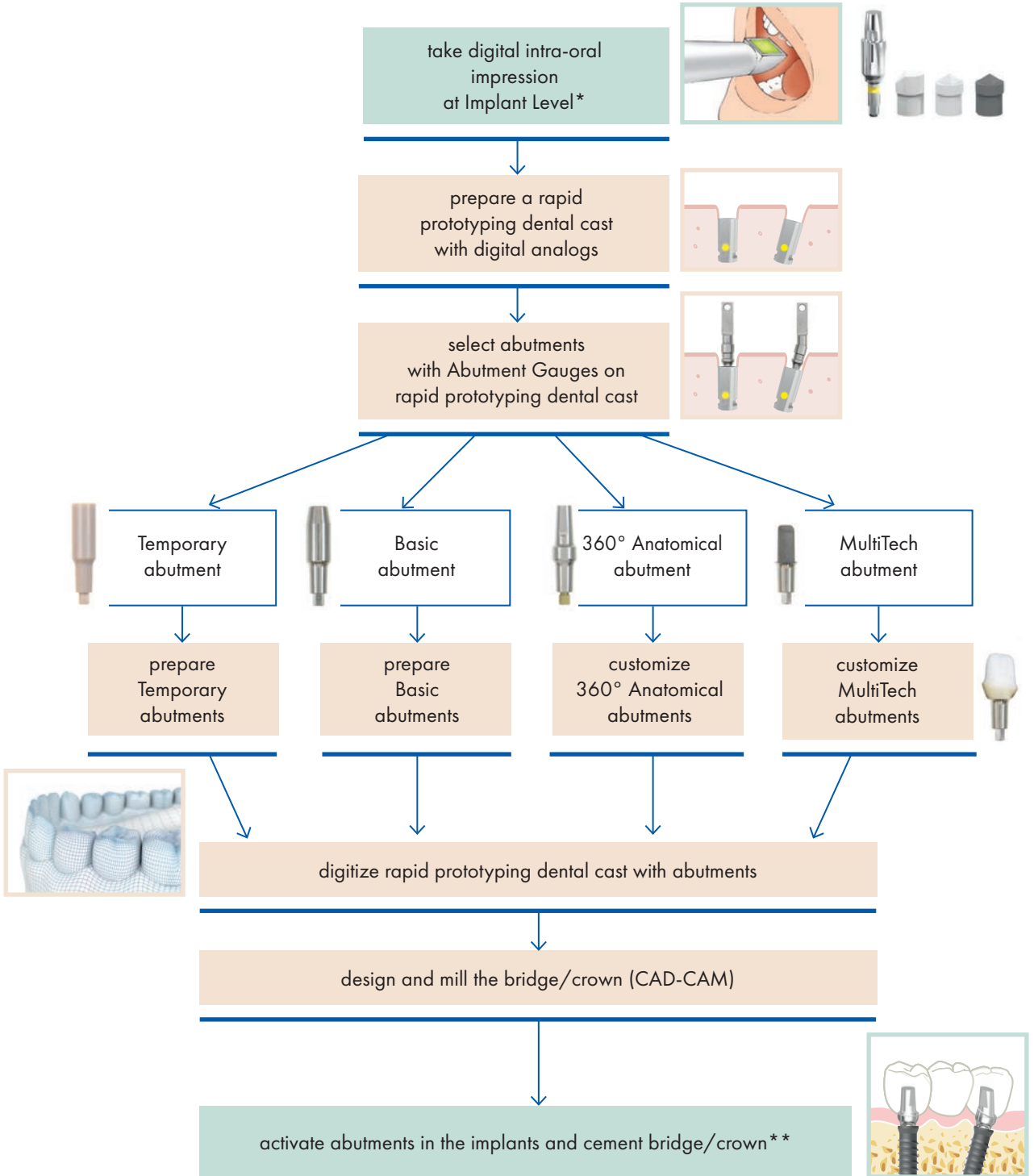

* Orientate the Scan Post so that the notch is on the buccal side.
 **In case of single crowns, option: extra-oral cementation.

→ Steps carried out by **THE CLINICIAN**
→ Steps carried out by **THE DENTAL LABORATORY**

DIGITAL PROSTHETIC WORKFLOW



SCREW-RETAINED SINGLE CROWN - ABUTMENT LEVEL

CHAIRSIDE TECHNIQUE

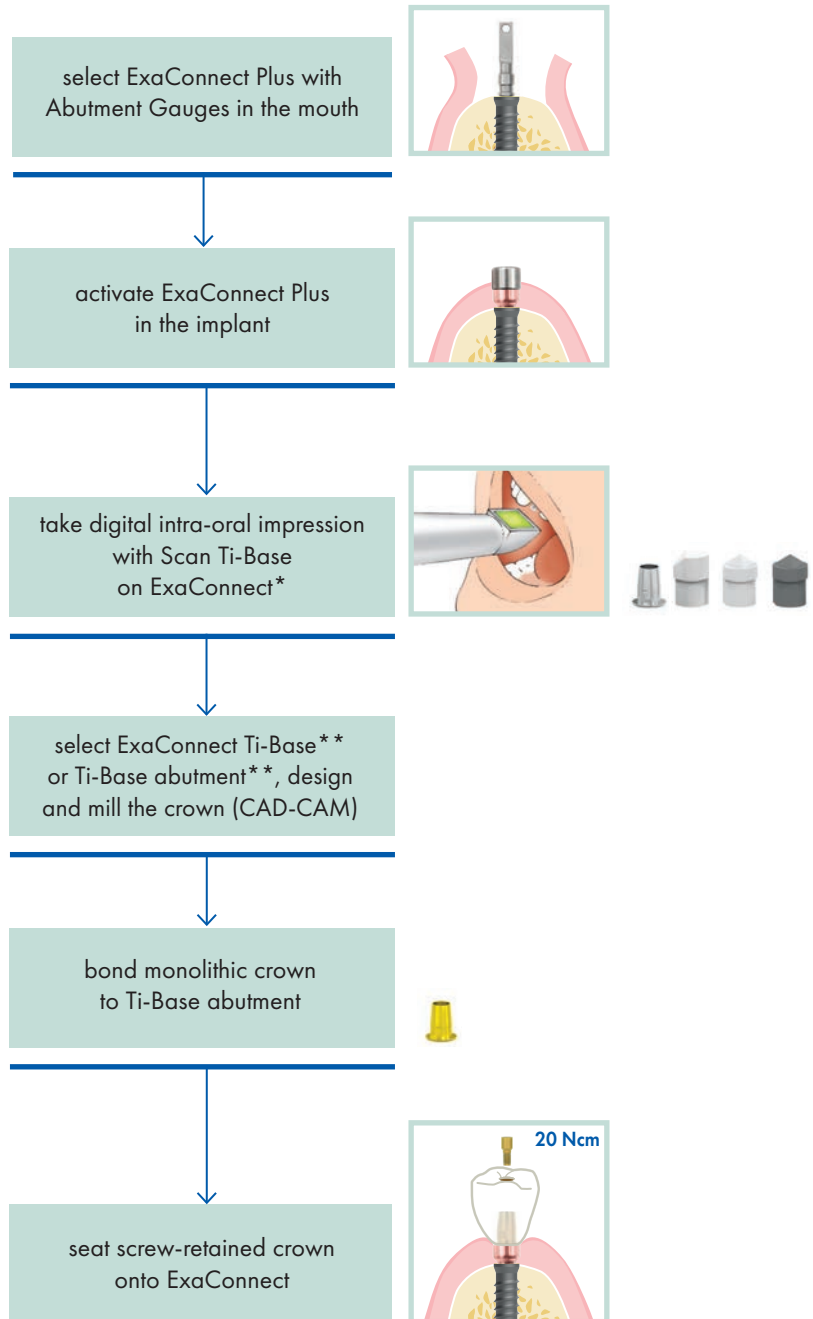

*Orientate the Ti-Base so that the notch is on the buccal side.

** As to dental CAD-CAM software including the specified products, please refer to Leone web site www.leone.it under section Implantology and download any updated library.

→ Steps carried out by **THE CLINICIAN**
→ Steps carried out by **THE DENTAL LABORATORY**

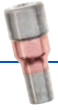

DIGITAL PROSTHETIC WORKFLOW

SCREW-RETAINED SINGLE CROWN - ABUTMENT LEVEL

CONVENTIONAL IMPRESSION TAKING

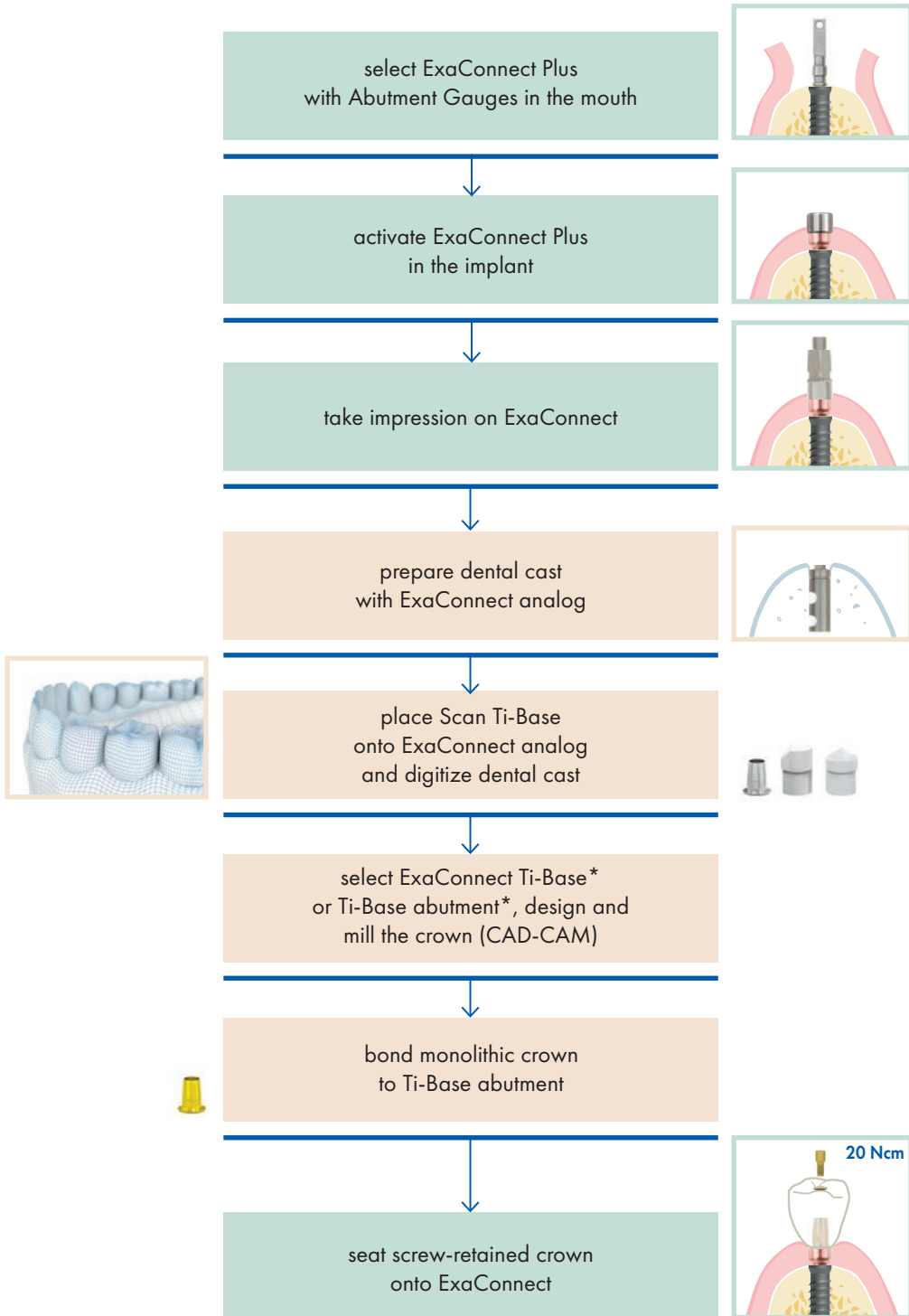

*As to dental CAD-CAM software including the specified products, please refer to Leone web site www.leone.it under section Implantology and download any updated library.

→ Steps carried out by **THE CLINICIAN**
→ Steps carried out by **THE DENTAL LABORATORY**

DIGITAL PROSTHETIC WORKFLOW



SCREW-RETAINED SINGLE CROWN - IMPLANT LEVEL

CONVENTIONAL IMPRESSION TAKING

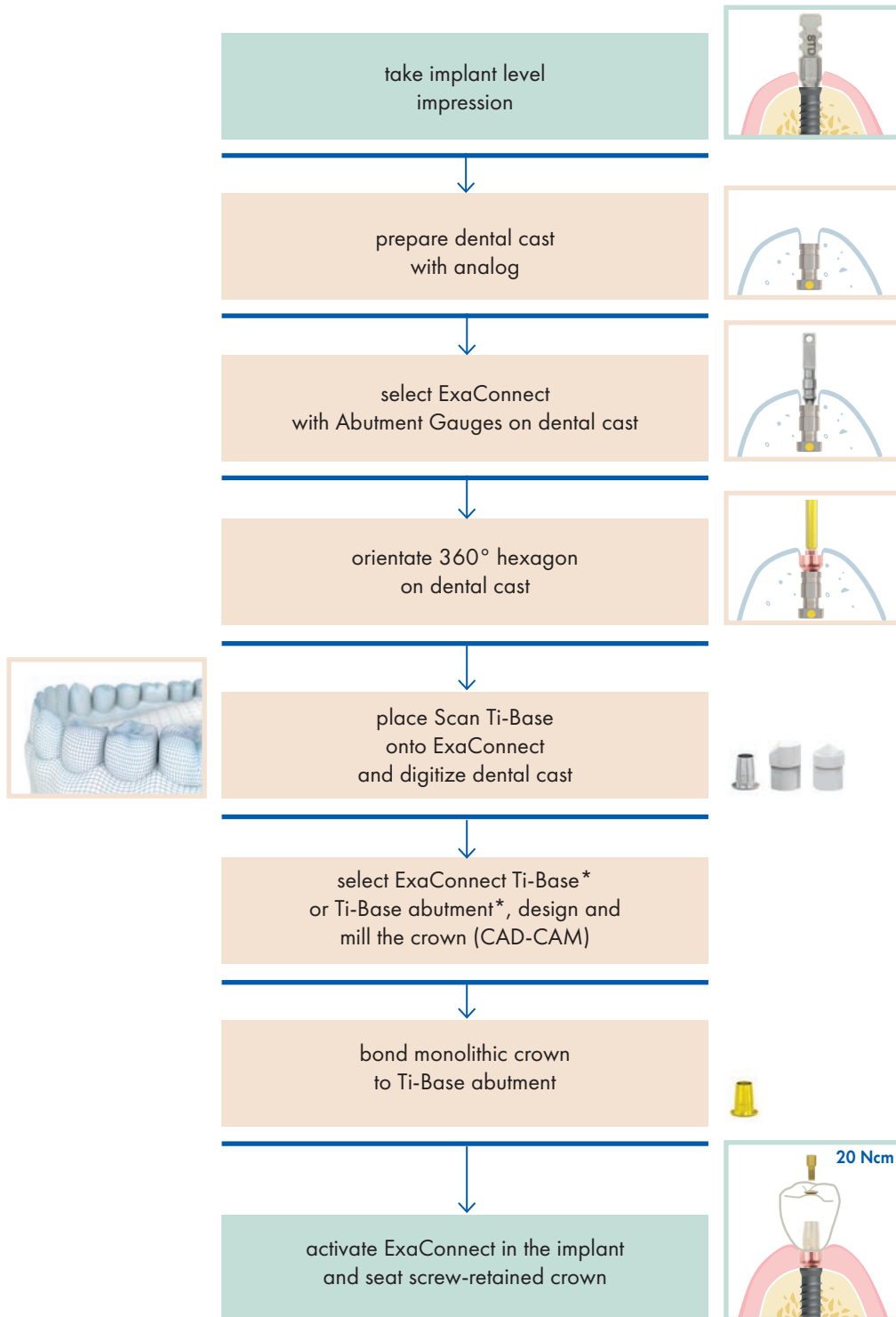

*As to dental CAD-CAM software including the specified products, please refer to Leone web site www.leone.it under section Implantology and download any updated library.

→ Steps carried out by **THE CLINICIAN**
→ Steps carried out by **THE DENTAL LABORATORY**

DIGITAL PROSTHETIC WORKFLOW



SCREW-RETAINED SINGLE CROWN - IMPLANT LEVEL

DIGITAL IMPRESSION TAKING

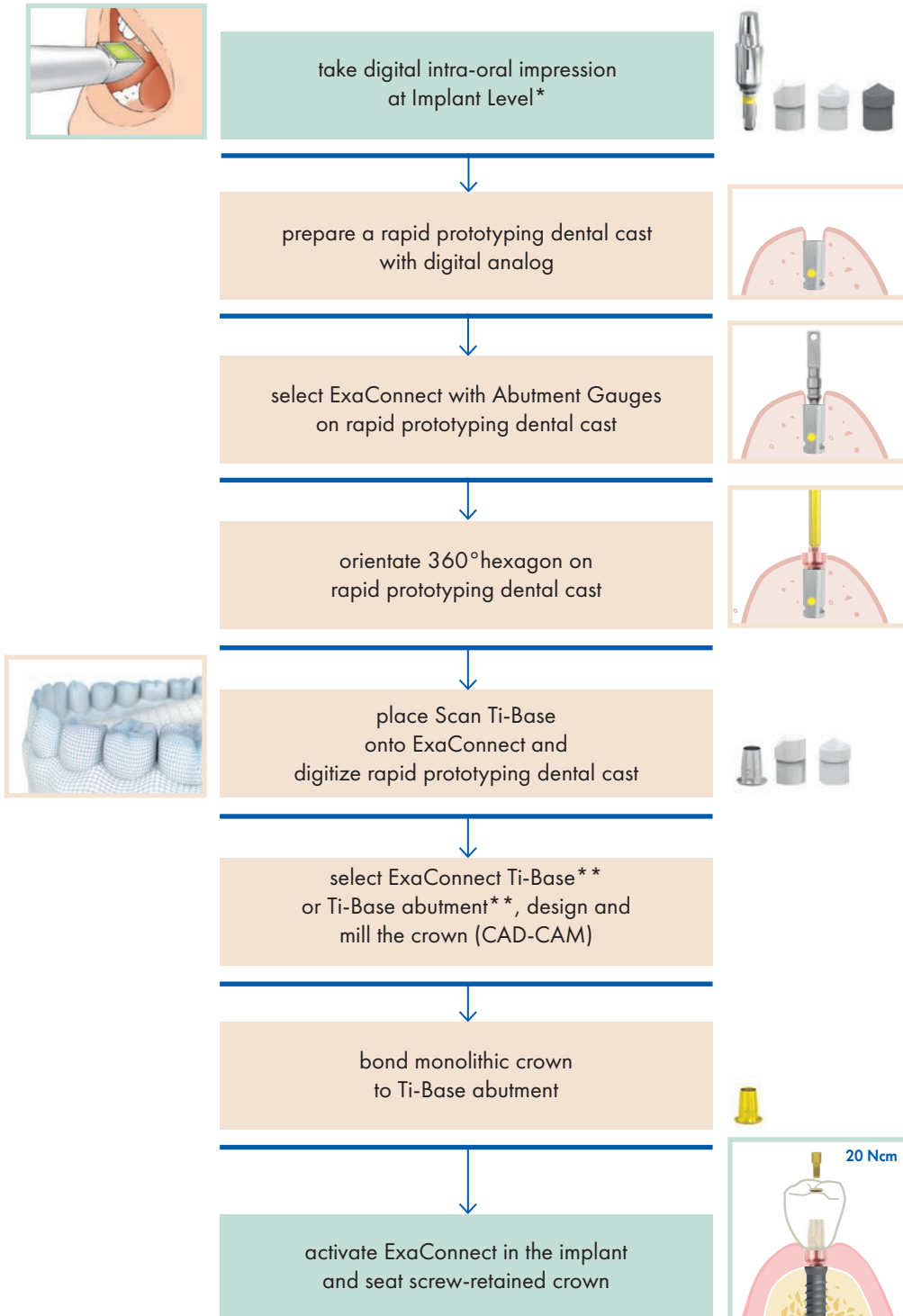

*Orientate the Scan Post so that the notch is on the buccal side.

**As to dental CAD-CAM software including the specified products, please refer to Leone web site www.leone.it under section Implantology and download any updated library.

→ Steps carried out by **THE CLINICIAN**
→ Steps carried out by **THE DENTAL LABORATORY**

DIGITAL PROSTHETIC WORKFLOW

SCREW-RETAINED BRIDGE/BAR - IMPLANT LEVEL

CONVENTIONAL IMPRESSION TAKING

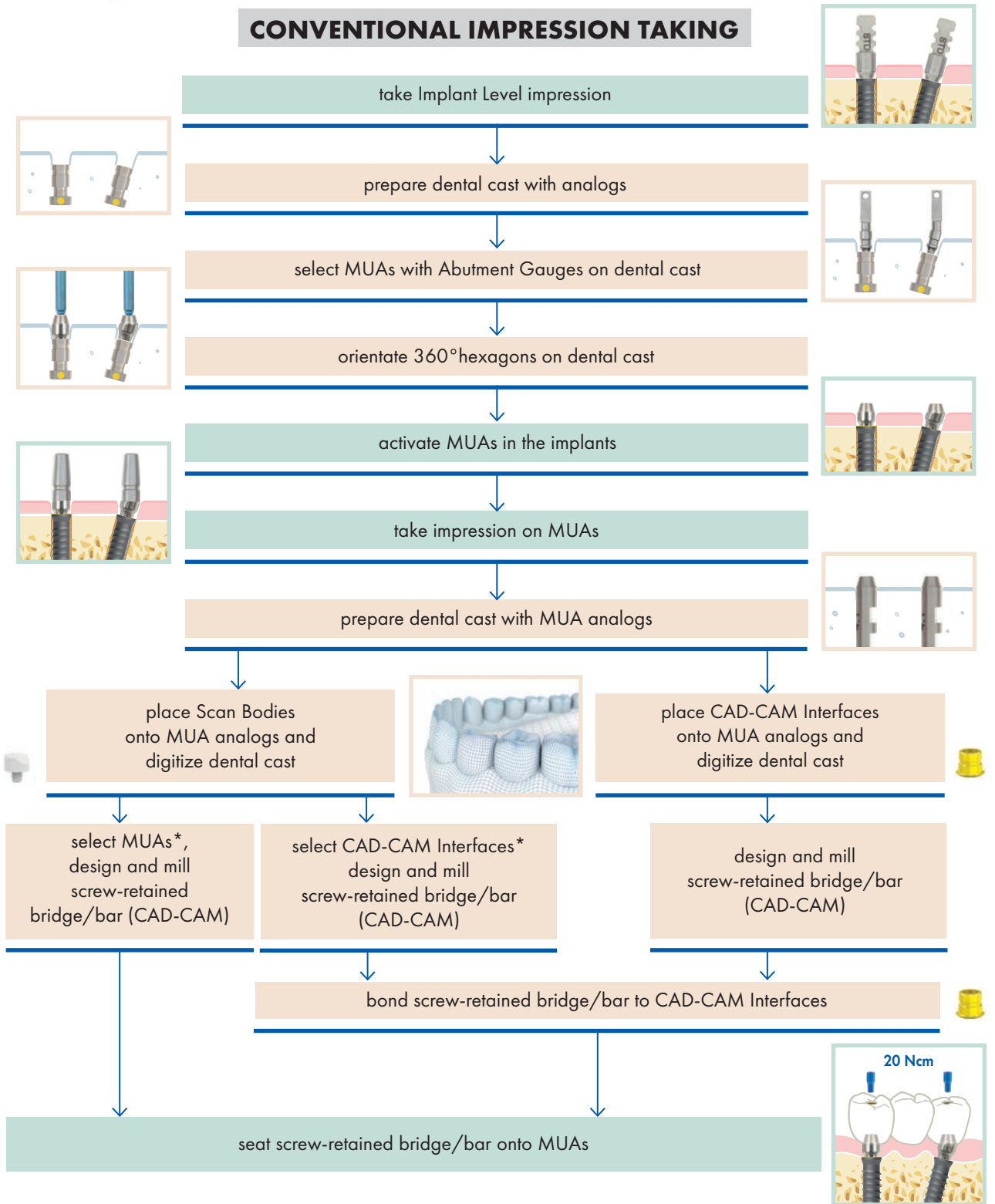

DIGITAL PROSTHETIC WORKFLOW



SCREW-RETAINED BRIDGE/BAR - ABUTMENT LEVEL

CONVENTIONAL IMPRESSION TAKING

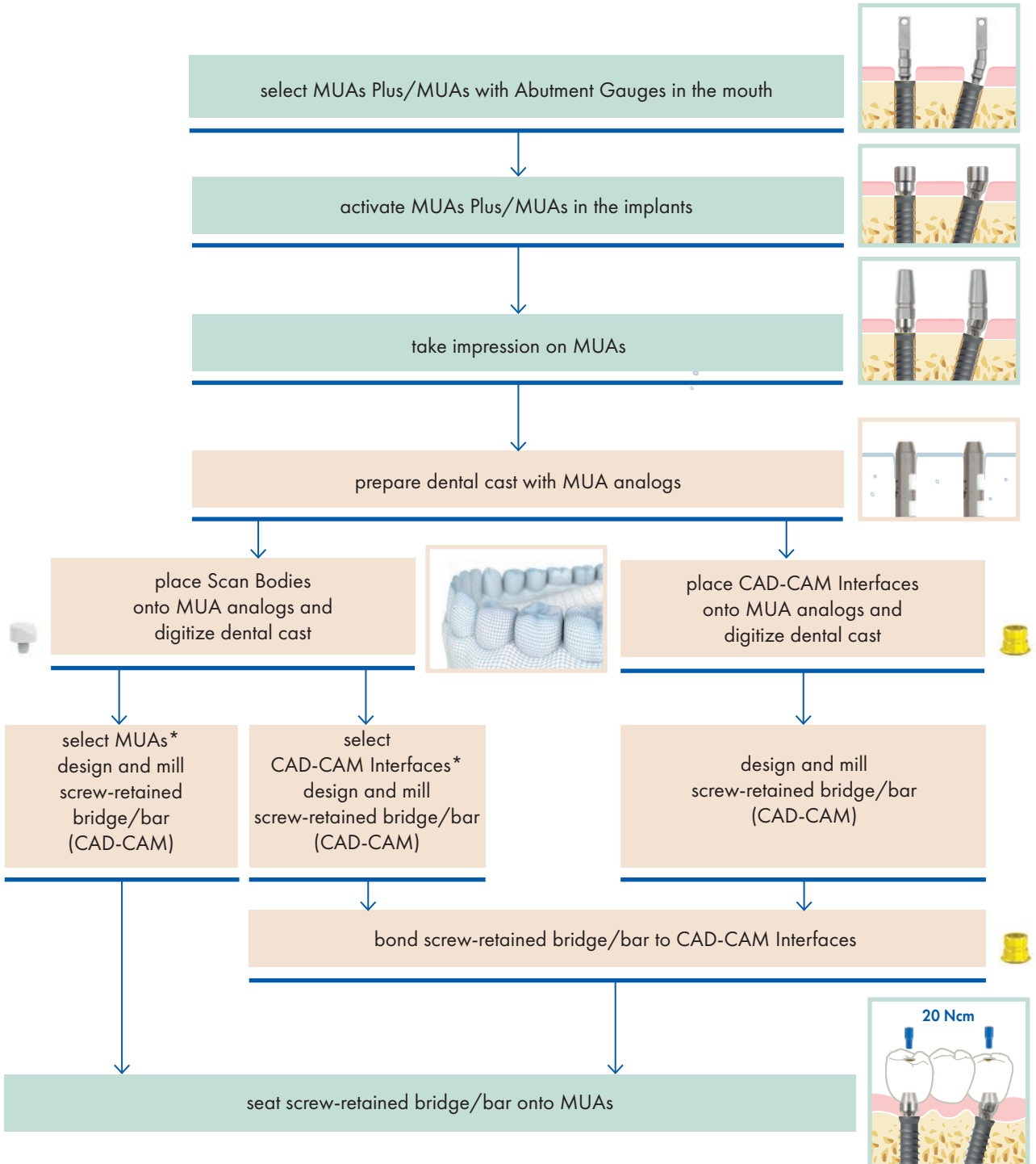

*As to dental CAD-CAM software including the specified products, please refer to Leone web site www.leone.it under section Implantology and download any updated library.

→ Steps carried out by **THE CLINICIAN**
→ Steps carried out by **THE DENTAL LABORATORY**



DIGITAL PROSTHETIC WORKFLOW

SCREW-RETAINED BRIDGE/BAR - ABUTMENT LEVEL

DIGITAL IMPRESSION TAKING

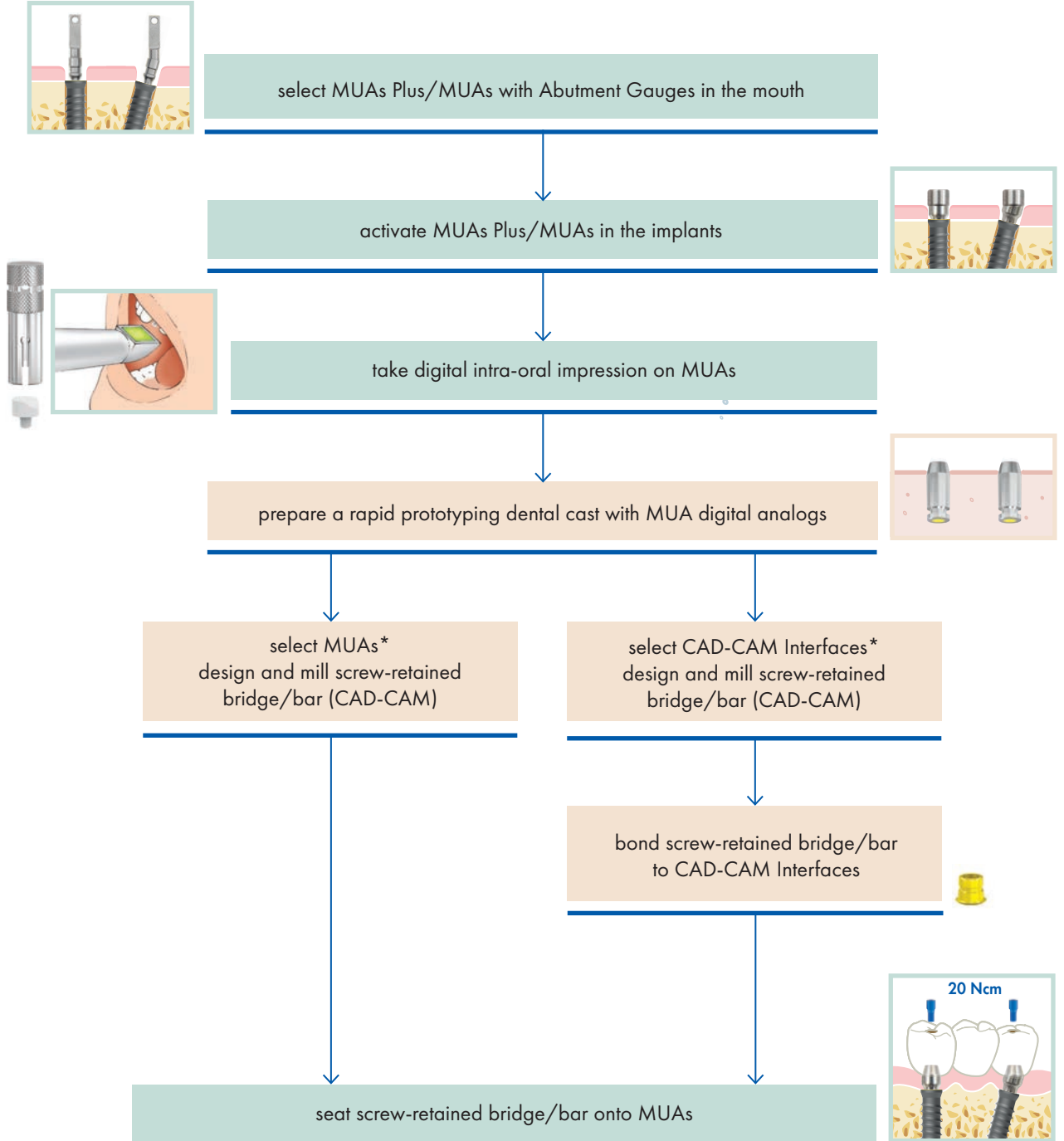

*As to dental CAD-CAM software including the specified products, please refer to Leone web site www.leone.it under section Implantology and download any updated library.

→ Steps carried out by **THE CLINICIAN**
→ Steps carried out by **THE DENTAL LABORATORY**

DIGITAL PROSTHETIC WORKFLOW

CONOMETRIC-RETAINED BRIDGE WITH FIXED CAPS

DIGITAL IMPRESSION TAKING

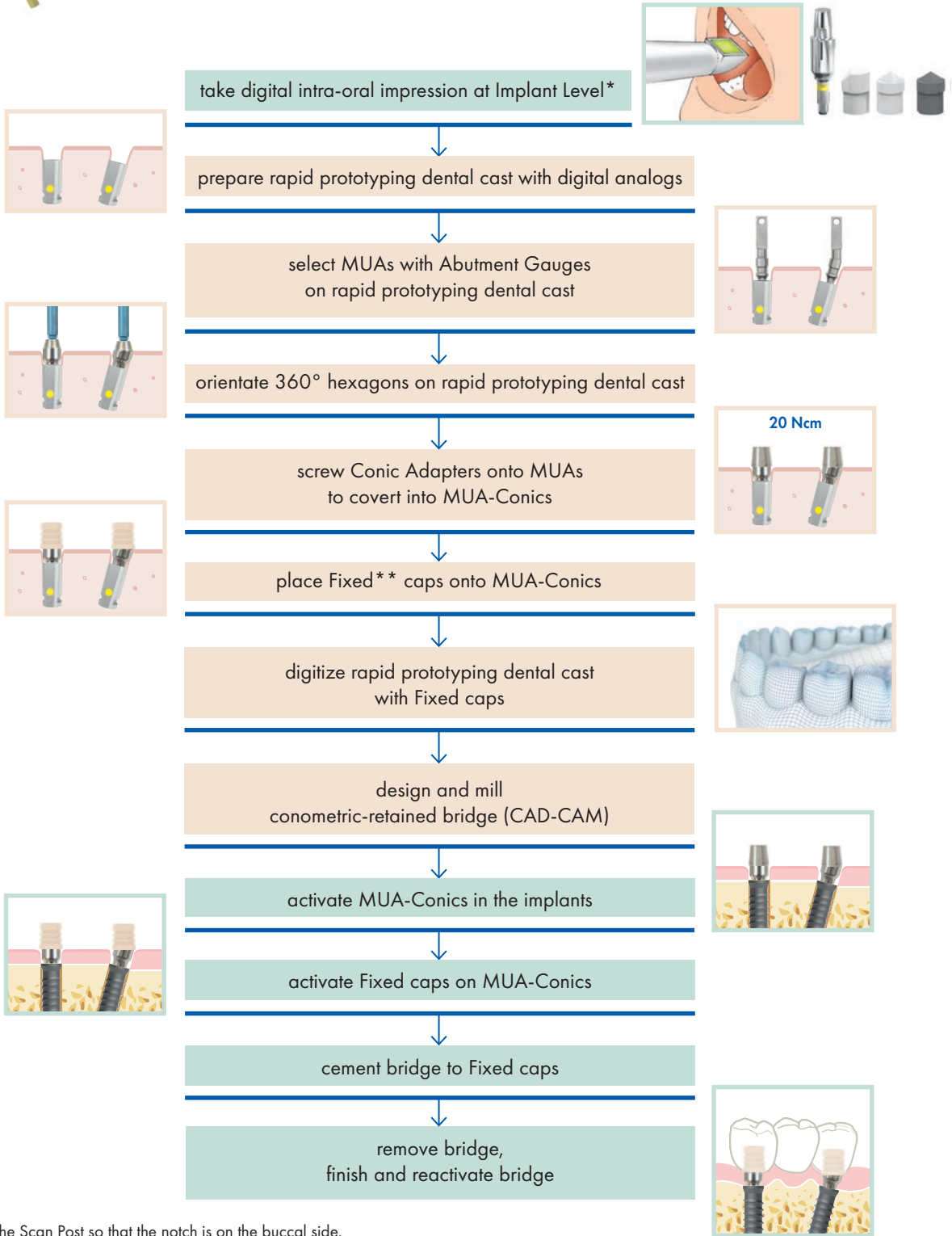

*Orientate the Scan Post so that the notch is on the buccal side.

** It is possible to combine the use of the *Light* cap to modulate the retention of the prosthesis (see page 79).

| → Steps carried out by **THE CLINICIAN**
| → Steps carried out by **THE DENTAL LABORATORY**

DIGITAL PROSTHETIC WORKFLOW

CONOMETRIC-RETAINED BRIDGE WITH FIXED CAPS

CONVENTIONAL IMPRESSION TAKING

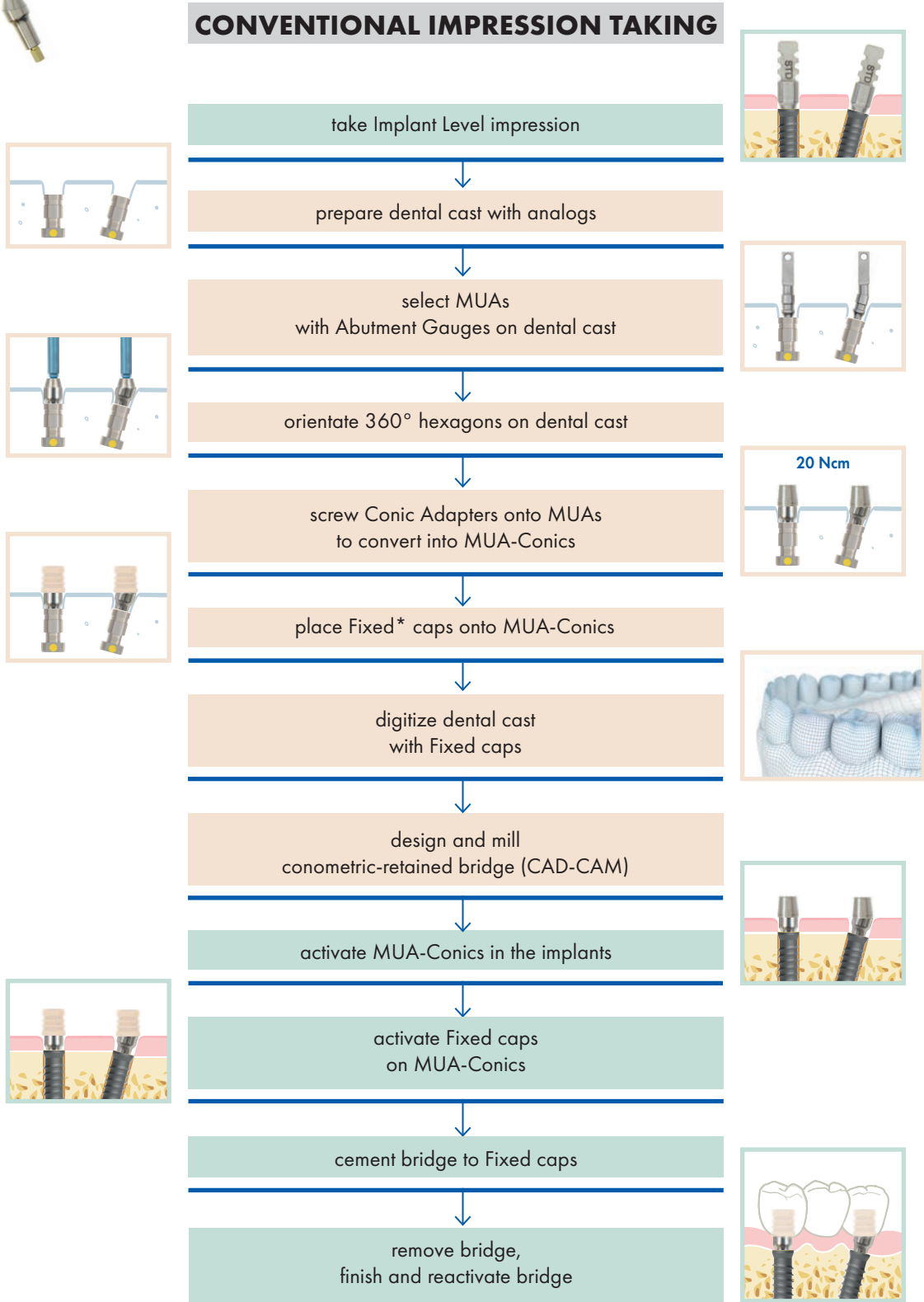

*It is possible to combine the use of the *Light* cap to modulate the retention of the prosthesis (see page 79).

→ Steps carried out by **THE CLINICIAN**
→ Steps carried out by **THE DENTAL LABORATORY**

DIGITAL PROSTHETIC WORKFLOW

CONOMETRIC-RETAINED FULL-ARCH WITH FIXED CAPS

CONVENTIONAL IMPRESSION TAKING

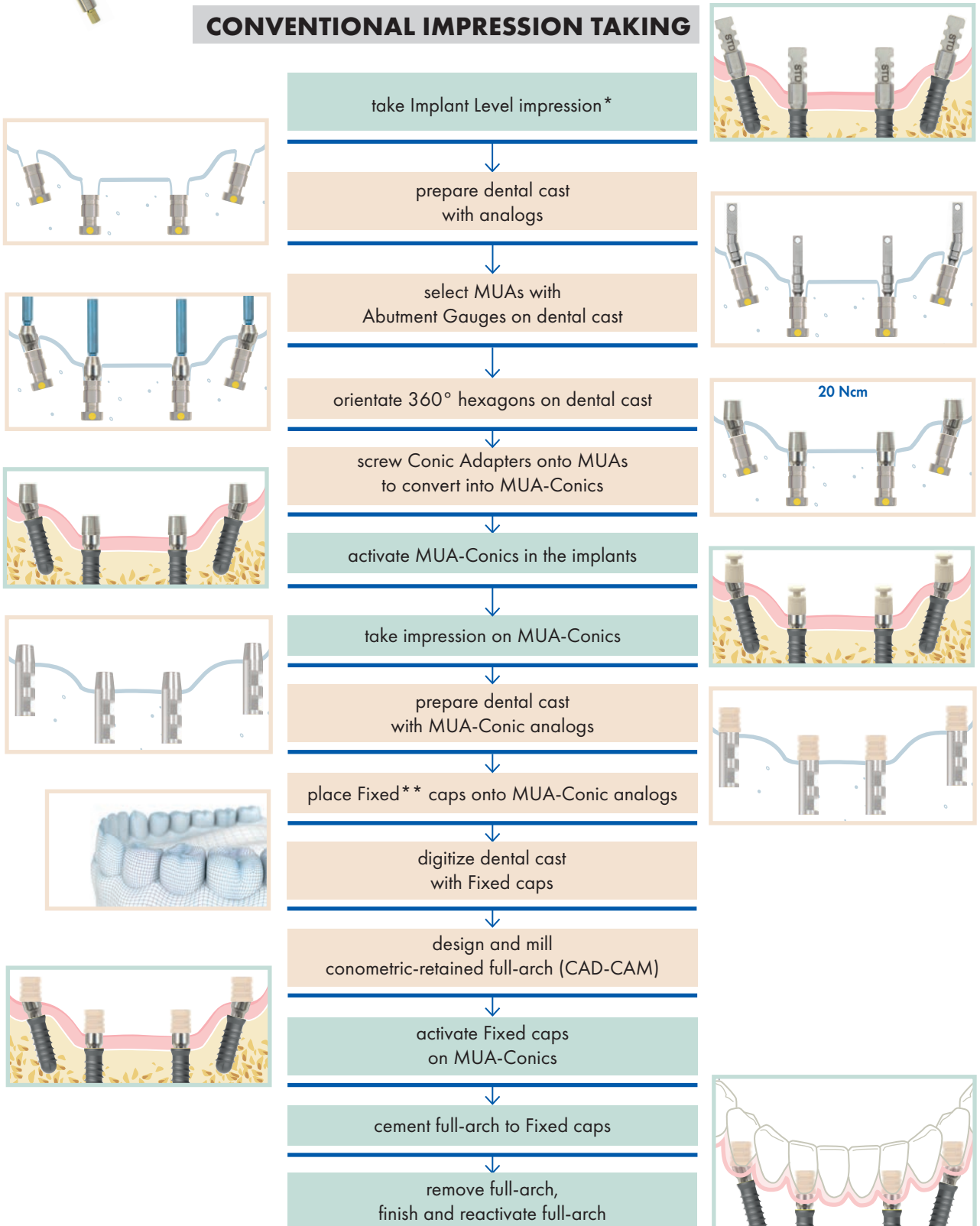

* Alternatively, take a digital intra-oral impression at Implant Level.

** It is possible to combine the use of the *Light* cap to modulate the retention of the prosthesis (see page 79).

Steps carried out by THE CLINICIAN

MONOIMPLANTS FOR O-RING OVERDENTURE



MONOIMPLANTS



Ideal for

- overdenture stabilization in atrophic edentulous mandibles

Features

- made of medical grade 5 titanium
- implant with integrated ball head
- smooth tapered neck
- cylindrical geometry of the endosseous portion
- atraumatic thread design (Standard ISO 5835)
- HRS surface (roughness $R_a \approx 1 \text{ mm}$)
- implant diameter of 2,7 mm
- 2 gingival heights (3 - 5 mm)
- 4 endosseous lengths (10 - 12 - 14 - 16 mm)

Leone monoimplant: minimally invasive and strong

The Leone monoimplant has been developed for the stabilization of overdentures in the lower jaw on 4 monoimplants placed at the level of mandibular symphysis, in the area between the two foramina.

The reduced diameter of only 2.7 mm allows for easy and minimally invasive insertion even in severely resorbed atrophic mandibles. Its self-tapping design provides excellent primary stability.

Despite the small implant diameter, it features a torsional resistance greater than 140 Ncm. The reduced size of the micro-housing permits re-use of existing dentures.



Monoimplants \varnothing 2,7 mm gingival height 3 mm

1:1



\varnothing (mm)	2,7	2,7	2,7	2,7
length (mm)	10	12	14	16
REF	111-2710-13	111-2712-13	111-2714-13	111-2716-13

Monoimplants \varnothing 2,7 mm gingival height 5 mm

1:1



\varnothing (mm)	2,7	2,7	2,7	2,7
length (mm)	10	12	14	16
REF	111-2710-15	111-2712-15	111-2714-15	111-2716-15

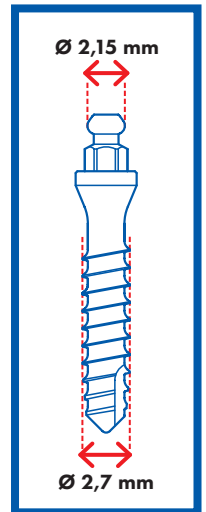

Sterile package

- 1 monoimplant
- 1 micro housing with micro O-ring
- 1 spacer ring for monoimplant (white)
- 1 spacer ring for abutments (grey)

HOUSING WITH O-RING

- made of medical grade 5 titanium
- O-ring pre-mounted inside
- retention force 10 N
- autoclavabile

Pack content:

- 1 housing with O-ring
- 1 spacer ring for abutments

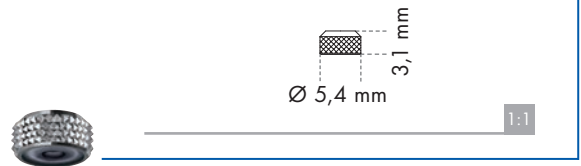

REF **123-0002-00**

O-RING

- made of elastomer
- refill for housing with O-ring
- autoclavabile

Pack of 10



REF **123-0001-00**

MICRO HOUSING WITH MICRO O-RING

- made of medical grade 5 titanium
- micro O-ring pre-mounted inside
- retention force 10 N
- autoclavabile

Pack content:

- 1 micro housing with micro O-ring
- 1 spacer ring for abutments (grey)
- 1 spacer ring for monoimplants (white)

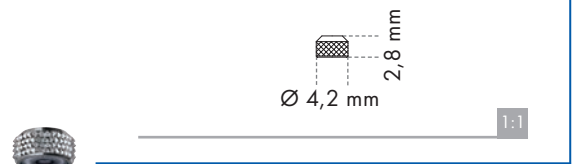

REF **123-0003-00**

MICRO O-RING

- made of elastomer
- refill for micro housing with micro O-ring
- autoclavabile

Pack of 10



REF **123-0001-01**

ORGANIZER FOR MONOIMPLANTS FOR O-RING OVERDENTURE

- 151-2215-20 mucosa punch for handpiece Ø 2,7
- 151-1930-02 lance drill
- 151-2222-42 pilot drill, long Ø 2,2 mm
- 156-2002-00 depth gauge
- 156-2004-00 2 measuring pins for gingival height
- 156-1015-00 fan-type wrench for monoimplants
- 156-1017-00 handpiece adapter for monoimplants



REF **156-0017-00**

MUCOSA PUNCH FOR CONTRA-ANGLE

- made of medical grade 5 titanium
- to punch the mucosa
- Ø 2,7 mm
- with marks at 3, 5 and 7 mm for the measurement of the gingival thickness
- autoclavable

Pack of 1



REF **151-2215-20**

MEASURING PIN FOR GINGIVAL HEIGHT

- made of medical grade 5 titanium
- for measuring the height of soft tissues and parallelism of the implant sites
- Ø 2,2 mm
- with a hole for the placement of a safety leash
- autoclavable

Pack of 1



1:1

REF **156-2004-00**

DEPTH GAUGE

- made of medical grade 5 titanium
- to verify the depth of the implant site
- Ø 2,2 mm
- with a hole for the placement of a safety leash
- autoclavable

Pack of 1



1:1

REF **156-2002-00**

FAN-TYPE WRENCH FOR MONOIMPLANT

- made of stainless steel and anodized aluminium
- to complete the placement of the monoimplant
- with hex hole matching with the monoimplant head
- with a hole for the placement of a safety leash
- autoclavable

Pack of 1



REF **156-1015-00**

RATCHET ADAPTER

- made of stainless steel
- allows the use of the ratchet for the placement of the monoimplant
- autoclavable

Pack of 1



REF **156-1016-00**

HANDPIECE ADAPTER

- made of stainless steel
- allows the use of the handpiece for the placement of the monoimplant
- autoclavable

Pack of 1



REF **156-1017-00**

TEMPLATE FOR MONOIMPLANT

To guide the clinician in the choice of the right monoimplant: technical drawings show monoimplants with 3 mm gingival height in 3 scales to match possible distortions created by the X-ray unit:

- actual dimensions 1:1
- dimensions increased by 10%
- dimensions increased by 25%

Pack of 1

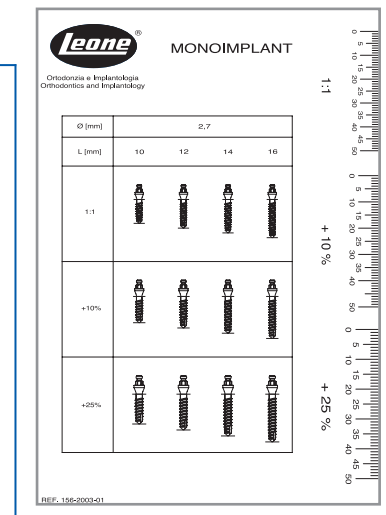

REF **156-2003-01**

SURGICAL AND PROSTHETIC PROCEDURE FOR MONOIMPLANTS FOR O-RING OVERDENTURE



The pictures and illustrations in this brochure are for information purposes only and they are not intended to replace the methods or procedures for diagnosis and treatment planning of the Dental surgeon, Dentist and Dental Technician regarding the needs of each patient. Leone Spa disclaims any liability or any other obligation expressed or implied in this brochure.

DISCLAIMER

The Surgical and Prosthetic Procedures related to the use of the Leone products for Monoimplants for O-ring overdenture described in the following pages are intended for Professionals experienced in dental implant techniques.

In case of lack of basic notions, we suggest to attend specific courses in order to reach a high level of knowledge and practice in the use of implants. The instructions for use of the products described below represent a sort of standard instructions that have to be adjusted to the individual needs and to the particular situations that may occur on the basis of the manual ability, the experience and diagnosis effected by the legally qualified medical operator. It is not ascribed to the manufacturer the duty of monitoring the procedures of use of the product. A correct and appropriate use of the instruments and products related to the LEONE Monoimplants for O-ring overdenture shall completely be reverted to the clinician. The surgical procedure hereunder described is merely indicative as any single treatment case is assigned to the experience of the operator. As every medical operator well knows, a correct procedure and a perfect manufacture of the prosthesis may sometimes be followed by not satisfactory results owing to particular situations not imputable to responsibility of the dental operator or the manufacturer.

TREATMENT PLANNING

Indications

The Leone Monoimplant for O-ring overdenture therapy is indicated in the treatment of the TOTAL LOWER EDENTULISM.

Contraindications

For contraindications and side effects read the instructions for use enclosed in the package of each product and available in our web site www.leone.it in the section Services/Quality.

PREOPERATIVE EXAMS

Before starting the surgical intervention, the patients have to be subjected to a series of exams; any single case has to be evaluated by the clinician.

Anamnesis

It is the first approach to the patient and it represents a fundamental tool to recognize both risk factors and contraindications. Moreover, anamnesis allows for the evaluation of patient's expectations, priorities, degree of compliance and motivation.

Anamnesis can help in evaluating the need for extra exams in addition to the routine ones (when the presence of pathologies that were not reported by the patient is suspected) and when particular situations drive to deem a complete medico-surgical exam may be necessary.

Objective exam

It consists of:

- inspection of the periodontal tissues, of the oral mucosa and of the teeth along with an initial evaluation of the occlusal relationships (skeletal Class, characteristics of the opposing arch and related potential problems, type of occlusion, interarch distance), of the presence of parafunctions, of the degree of oral hygiene, of the aesthetic conditions, of the morphology of the edentulous crest and the space available for the replacement of the prosthesis.
- palpation of the soft tissues and implant sites for a preliminary evaluation of the bone morphology and thickness.
- a complete periodontal probing for the appraisal of the absence of both gingivitis and pockets.

Radiographic exams

PANORAMIC RADIOGRAPH: frequently, this radiograph allows an appraisal of the bone height and the relationships between implant site and adjacent structures, such as mandibular canal, etc.

It is also possible to identify concavities and ossification defects due to previous tooth extractions.

INTRAORAL RADIOGRAPH: it is very helpful for the determination of the apico-coronal availability of bone.

LATERAL CEPHALOGRAM: it is useful for the determination of the mandibular symphysis.

COMPUTERIZED TOMOGRAPHY: it is advisable to remind that previous radiographic exams provide two-dimensional images which do not give information on bone thickness. In order to obtain this useful information a computerized tomography is necessary: it provides three-dimensional images, thus allowing for an accurate evaluation of bone morphology and, sometimes, bone density.

Instrumental or laboratory exams

When necessary, in cases where a pathology is suspected on the basis of anamnesis or clinical records.

MONOIMPLANT SELECTION

The dimensions (implant length and transmucosal neck height) of the monoimplants to be seated are determined by the following factors:

1. amount of bone available
2. characteristics of the implant site
3. thickness of the soft tissues in the areas involved.

Further and particular individual situations must be evaluated by the Dentist or the Dental Surgeon.

Do not place monoimplants in the upper arch.

A template is available that shows all Leone monoimplants GH3 in actual dimensions, with dimensions increased by 10% and increased by 25%, to match possible distortions created by the X-ray unit.

To simplify the surgical operation, an organizer for monoimplants is available to sterilize and hold on the surgical field the necessary instruments.

LEONE SURGICAL INSTRUMENTS ARE SUPPLIED NON-STERILE: CLEANING, DISINFECTION AND STERILIZATION AFTER REMOVAL FROM THE PACKAGE AND PRIOR TO EACH FURTHER USE ARE REQUIRED. CONSULT THE *"Guidelines for cleaning, disinfection and sterilization of reusable XCN® Leone instruments"* AVAILABLE FOR DOWNLOAD AT www.leone.it IN THE SECTION Services/Quality.

Interactions between dental implant and medical imaging techniques

Titanium dental implants hardly are not magnetic and are not heated during a Magnetic Resonance Imaging (MRI) and the artifacts on the bioimage are usually attributable to the implant-prosthetic device. For further details please refer to the document "Interactions between Leone orthodontic and implantology devices and medical imaging techniques" available for download at www.leone.it in the section **Services/Quality**.

1. PREPARATION OF THE IMPLANT SITE

The access to the surgical site shall be selected by the professional according to the clinical-morphological parameters. Schematically and with illustrative purpose only, the following steps for the preparation of the implant site are illustrated.

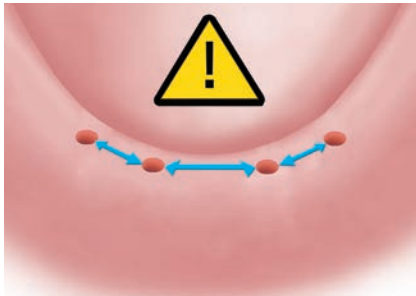

minimum 6 mm

1.1 After adequate treatment planning, clearly mark the locations where the monoimplants must be inserted with a marker pen or a surgical template.

The Leone monoimplants must only be inserted in the mandible, at the level of the mandibular symphysis, located in the area between the two foramina.

The number of monoimplants required to adequately support a removable prosthesis is 4. The minimum required space between each implant and the next is 6 mm. This will allow the correct positioning of the micro housings.

The inclination of every single implant shall not exceed 8° to the axis of parallelism.

Make sure that the prosthesis is tissue borne and only implant retained. Avoid any implant-prosthetic load on the monoimplants since they are strictly a retentive element.

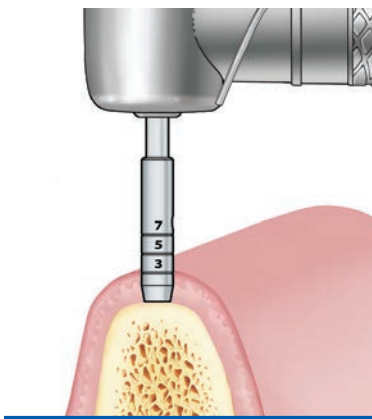

1.2a Flapless procedure

Punch the mucosa with the use of the special Ø 2,7 mucotome for handpiece. Use the mucotome with the micromotor set to a low speed (approx. 40 rpm). Use until bony tissue is met. On the mucotome there are three reference lines, at the heights of 3-5-7 mm starting from the crestal bone and acting as a reference for the measurement of the gingival height.

Remove the mucosa punch and the tissue plug by using a small periosteal elevator.

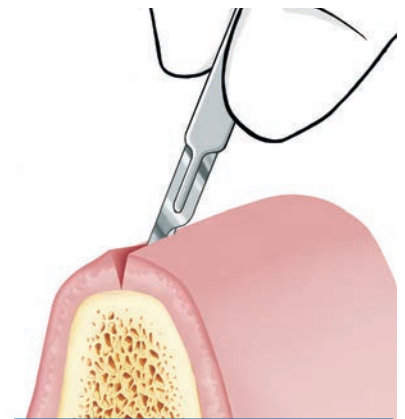
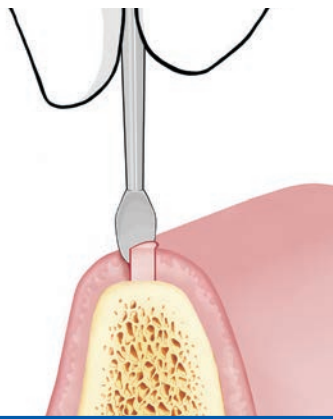

1.2b Flapping procedure

In case there are uncertainties on the condition of the crestal bone or the quantity of bone available, the use of a gingival flap procedure is advisable. Start with a scalpel incision of the soft tissues, then open the gingival flap for a clearer vision of the crestal bone: the osteotomy can now be performed.

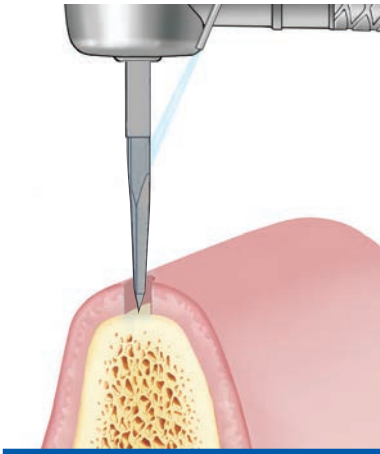

1.3 Once the gingival tunnel has been performed, use the round bur or lance drill to mark the cortical bone for the pilot drill.

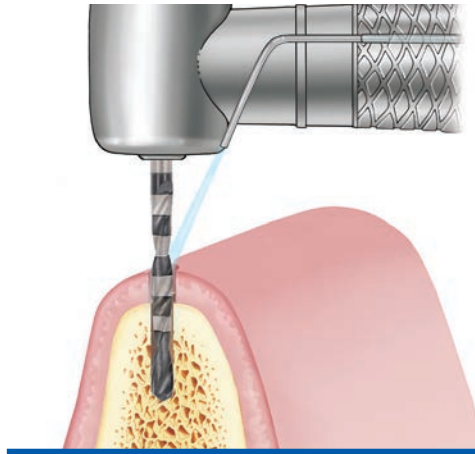

1.4 Insert the long pilot drill \varnothing 2,2 mm into the hole and drill the bone until the length of the desired monoimplant has been reached (max. speed of 800 rpm with adequate irrigation). The drilling depth is clearly indicated by black DLC (Diamond-Like Carbon) coated depth marks on the drill. Pay attention to the length of the monoimplant, to which the height of the soft tissues has to be added.

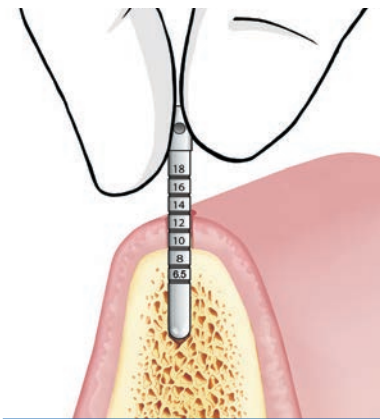

1.5 Insert the depth gauge into the newly created implant site to check its depth, considering also the height of soft tissues.

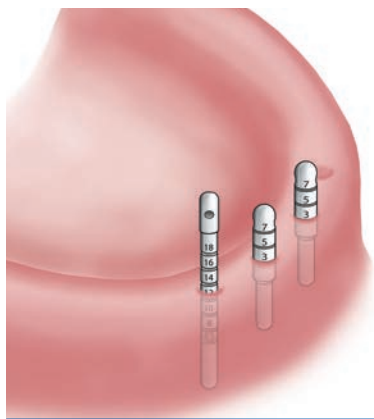

1.6 Repeat points 1.2 - 1.5 for the other three monoimplants, ensuring the maximum degree of parallelism among the surgical sites. Check the parallelism of the monoimplants using the measuring pins for gingival height and the depth gauge. The measuring pins may also be used at any other time to check soft tissue thickness.

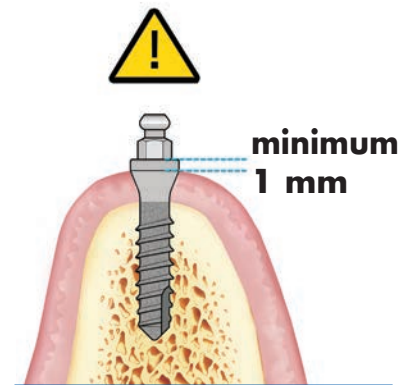

1.7 Choose the transmucosal neck height of the monoimplant. The head of the monoimplant must protrude from the gingiva by at least 1 mm to avoid a possible impingement of the micro housing on the patient's soft tissues.

2. MONOIMPLANT PACKAGING

The monoimplant is supplied with the micro housing in a sealed envelope that also carries the relevant product information. The packaging features a double protection to preserve the sterility of the implant subjected to a certified gamma X-ray process. Part of the label showing the information of the implant is removable for the "Implant Card" or the clinical case sheet of the patient. A sterility indicator is present on the vial.

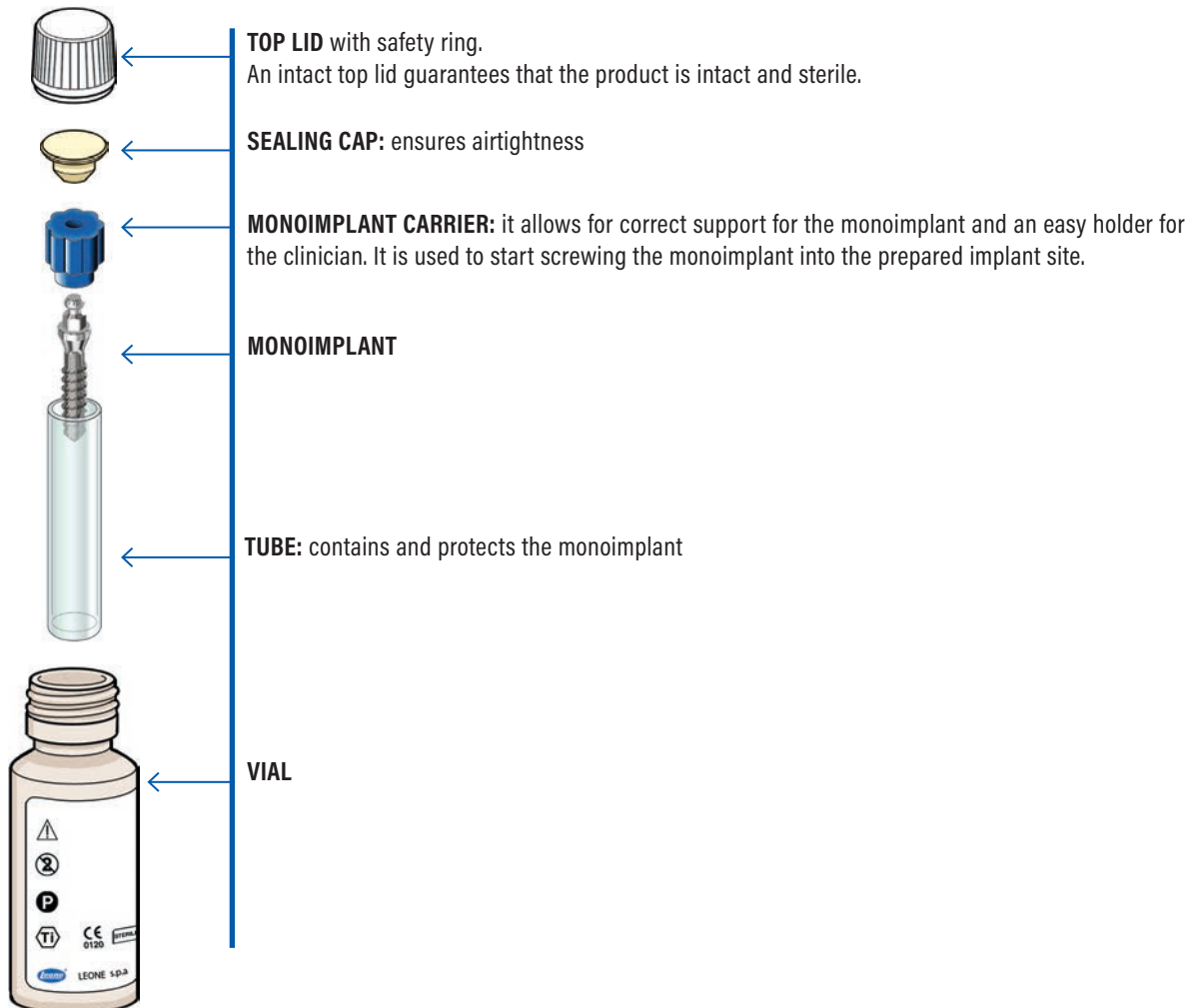

3. INSERTION OF THE MONOIMPLANT

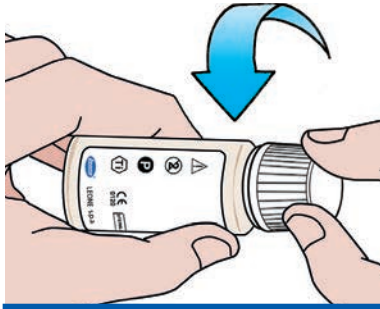

3.1 Unscrew the vial's top lid.

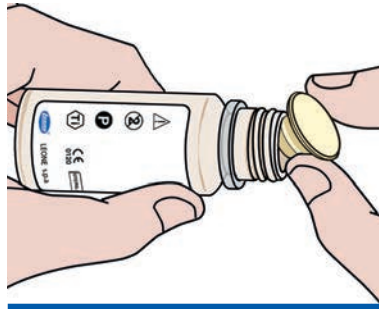

3.2 Remove the sealing cap.

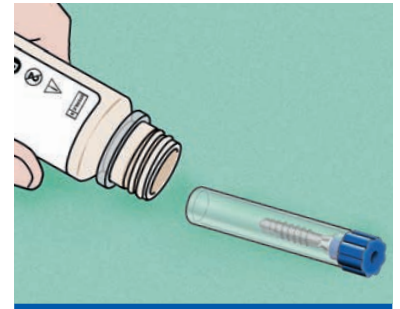

3.3 Extract the tube containing the monoimplant from the vial then lay it gently onto the sterile pad.

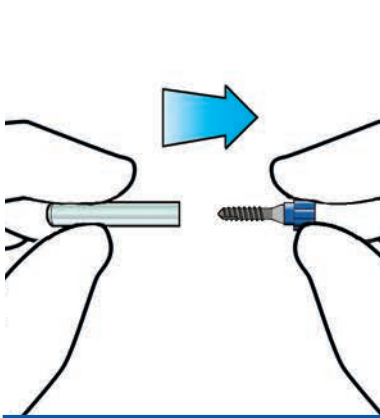

3.4 Hold the tube with one hand while gently pulling out the monoimplant with the other. Hold the monoimplant by the monoimplant carrier.

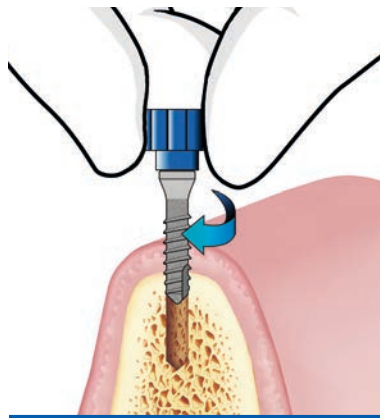

3.5 Still holding the monoimplant by the monoimplant carrier, insert it into the implant site with clockwise movement, while exerting a light downward pressure. Leone monoimplants are self-tapping.

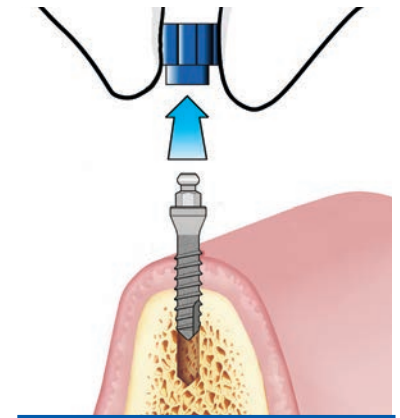

3.6 Remove the monoimplant carrier by pulling up.

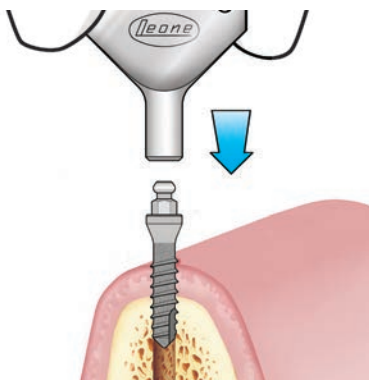

3.7 Position the fan-type wrench onto the head of the monoimplant. The wrench has a hole sideways for the insertion of a safety leash.

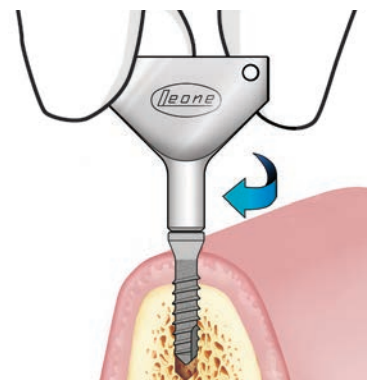

3.8a Screw the monoimplant in with a clockwise motion, until insertion is complete.

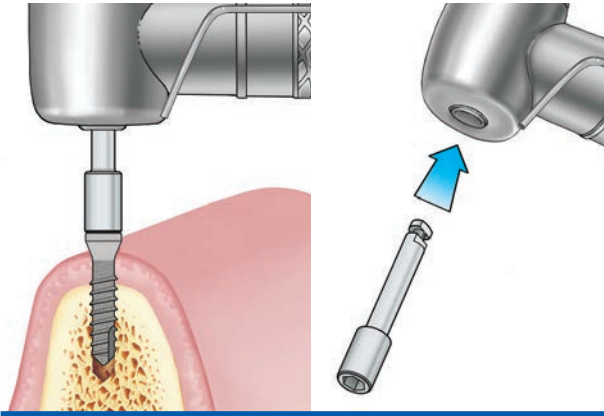

3.8b Alternatively, the monoimplant may be inserted with a contra-angle handpiece, using the contra-angle adapter. Set a micromotor's maximum speed to 20 rpm and a maximum torque value to 50 Ncm.

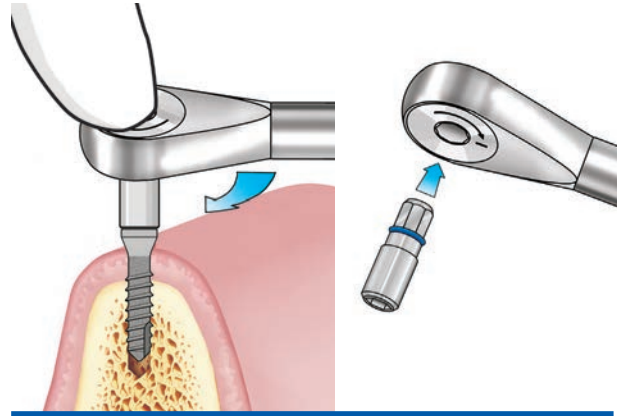

3.9 In case of particularly hard bone, the monoimplant can be inserted with the ratchet, using the specific adapter.

N.B.: Should a ratchet be used to complete the insertion, it is recommended that the clinician should lightly press the head of the instrument with a finger during action, to keep the head perpendicular with the implant.

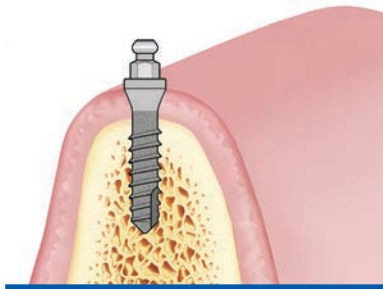

3.10 Once the monoimplant is in place, the base of the tapered section of the head should sit level with the crestal bone, while the head should stick out of the gum.

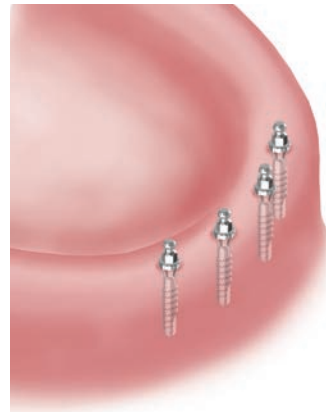

3.11 Repeat steps 3.1 – 3.10 for the remaining three monoimplants. Should a flapping technique be used, suture soft tissues around the monoimplants and load implants after healing has taken place. In the meantime relieve the existing prosthesis around the spherical heads of the monoimplants and fill the holes with soft acrylic.

4. PREPARATION OF THE REMOVABLE PROSTHESIS

During relining of the pre-existing prosthesis or manufacture of a new one, provide a wide tissue support for the prosthesis. Particular care must be taken to ensure complete tissue support of the prosthesis during the subsequent periodic checks, relining, as needed.

CAUTION: it is recommended to deliver the final prosthesis in the initial phase without housings to allow for adequate tissue adaptation and to correct possible impingements. The clinician will determine the length of the adaptation period.



4.1 Once the prosthesis is ready apply some soft wax on the inside surface of the prosthesis or dab the spherical heads of the monoimplants with a marker pen to reveal their location in the prosthesis.



4.2 Using the marks thus obtained in the prosthesis as reference, hollow out the areas needed to adequate diameter to receive the micro housings.

CAUTION: if you are not sure whether the monoimplants have achieved adequate primary stability, we recommend relining the prosthesis with soft acrylic and waiting for a minimum of 3 months for osseointegration before incorporating the housings into the prosthesis.

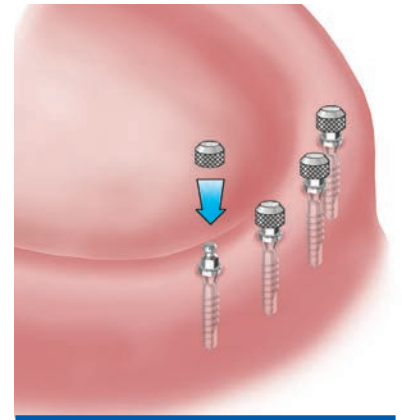

4.3 Place the micro housings on the spherical heads of the implants then press down until seated. Slight lack of parallelism can be overcome by using the housings instead of the micro housings.

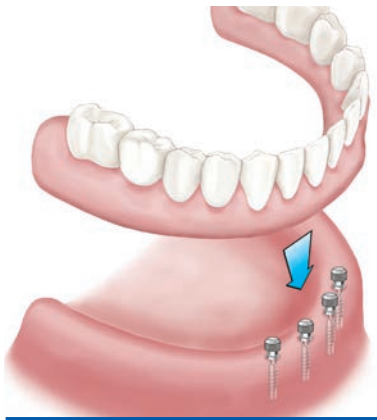

4.4 Insert the prosthesis in the patient's mouth for the final check. It should be free from friction and unwanted contacts. The prosthesis may be relieved corresponding to the micro housings in order to obtain a perfect tissue borne prosthesis without any friction on the housings.

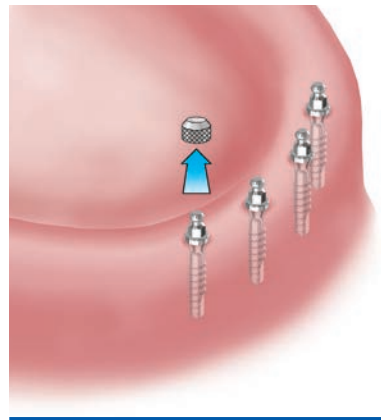

4.5 Remove the prosthesis and micro housings from the implants.

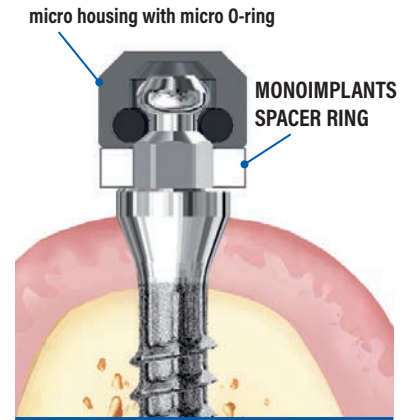

4.6 Place the white spacer ring over the monoimplant. This spacer ring is used to correctly position the micro housing, or the standard housing, into the prosthesis and minimize acrylic seeping into the undercuts of the spherical heads of the monoimplants.

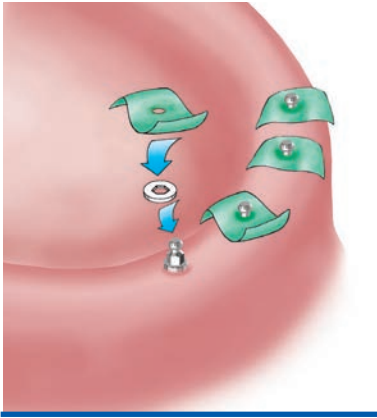

4.7 Place squared pieces of rubber dam over each monoimplant to avoid a direct contact between the soft tissue and the acrylic.

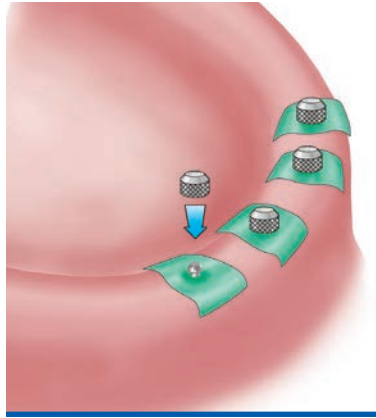

4.8 Place the micro housings onto the monoimplants. Please remember that all housings should be incorporated into the prosthesis at the same time. Do not attempt to place them individually.

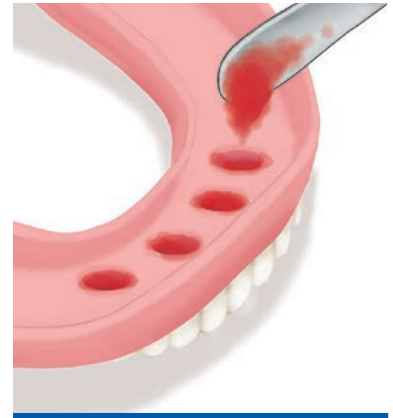

4.9 Fill the 4 cavities in the prosthesis with self-curing acrylic and also on the micro housings.

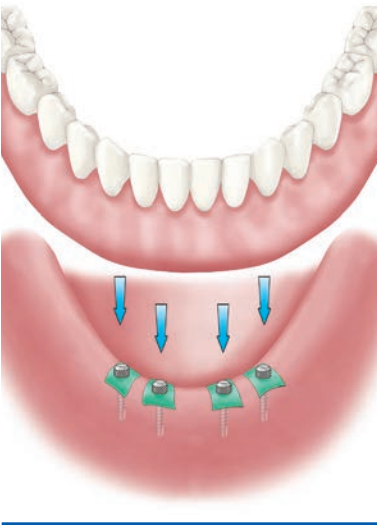

4.10 Fit the prosthesis in the mouth of the patient looking for adequate occlusal contact. The patient should not close the mouth too tightly.

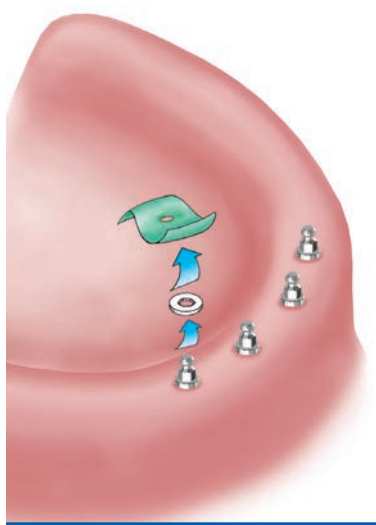

4.11 After the polymerization of the acrylic has been completed, the prosthesis is removed from the patient's mouth. The micro housings, due to their highly retentive surface, are kept in the prosthesis. Remove the rubber dams and the spacer rings from the monoimplants' heads.



4.12 Remove any acrylic excess until the edges of the micro housings are completely exposed. Correct any discrepancies that may interfere with proper seating of the appliance. Finish and polish the prosthesis.



Prosthesis maintenance

Patients should be seen at least once every six months. Review should include assessment of prosthesis retention and replacement of damaged O-rings. In case of prosthesis relining, at the end of the procedure always replace the O-rings. If a simple prosthesis relining procedure is insufficient and it is necessary to reincorporate the metal housings into the prosthesis, remove the housings with a small bur and replace them with new housings following the above-mentioned procedure (points 4.6 - 4.12). Please remember that all the housings within the prosthesis should always be reincorporated together into the prosthesis and not only one or part of them.



Replacing an O-ring

When replacing an O-ring, remove the old O-ring from the metal housing and lubricate the new O-ring with silicone spray or Vaseline to facilitate placement within the metal housing. Insert the new O-ring into the housing by using plastic forceps. Use a round-shaped instrument which can enter into the hole of the O-ring to push it into its seat with small circular movements. To improve visibility we recommend to work using a magnifier with a magnification of at least 4x.

IMPLANT SYSTEM

XCN[®]

3D *Leone*

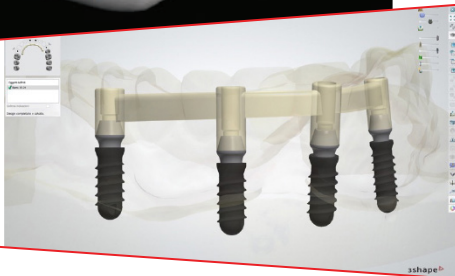
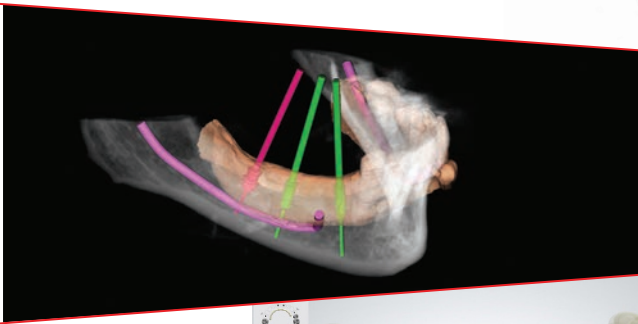

3DLEONE SERVICES

The 3DLeone Department is highly specialized in digital technologies for implant-prosthetic treatment and aims to facilitate the use of software both in diagnostics and planning as well as prosthetic fabrication.

SUPPORT FOR GUIDED SURGERY

The Leone Guided Surgery method is the result of a synergistic process based on the professional knowledge of the clinician and the technician. It is carried out using digital instruments, dedicated surgical and laboratory devices with the technical support and online tutoring of our 3DLeone department.

The availability of 3D files of Leone's devices in the libraries of the most widely used software programs allow to plan the position of the implants on the basis of the anatomical conformation and of the specific prosthetic needs.

The project is realized in the design of a CAD-CAM surgical guide that permits the use of the innovative ZERO1 drill (*patented*) for the realization of the osteotomy with maximum operational simplicity, safety and great precision.

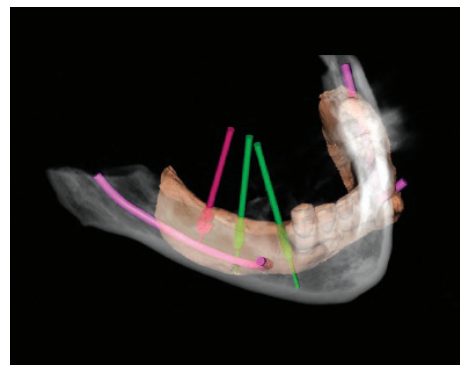

SUPPORT FOR DIGITAL PROSTHETICS

The most popular prosthetic software programs have our dedicated prosthetic components in the library that allow the fabrication of single teeth, cement-retained, screw-retained and conometric-retained bridges and bars by CAD-CAM production, making it possible to meet all the needs of the clinician and the patient.

On the Leone website you can download the libraries of the CAD-CAM software in which the Leone system is present: www.leone.it/english/implantology

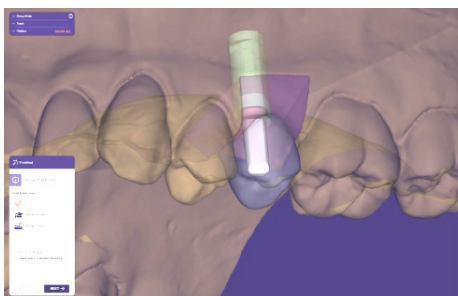

CONTACTS

- visit www.3dleone.it
- or contact us at 3d@leone.it

QUALITY FOR THE SATISFACTION OF THE CUSTOMER

The Leone S.p.A. quality system ensures and maintains the quality level of the product in accordance with the essential requisitions of 93/42 EEC Directive as amended, with the EU Regulation 2017/745 or other mandatory provisions and In compliance with the expectations and the needs of the customer, and ensures that all processes and their interactions associated with the manufacturing of orthodontic and dental products, more specifically the research and development production processes, storage and distribution are established, implemented, maintained and improved in accordance with the requirements of the quality management system in conformity with the international standards UNI EN ISO 9001, UNI CEI EN ISO 13485, under the regulation 93/42EEC in Annex II (Annex IX, Regulation EU 2017/745) and ISO 13485 in conformity with the requirements of the Countries participating at the program MDSAP (Medical Device Single Audit Program) such as: SOR 98/282 Canada, USA-FDA 21 CFR Part 820, Japanese Ordinance MHLW No. 169, Therapeutic Good (Medical Devices) Australian Regulation 2002, Resolution RDC Anvisa no.16/2013 of Brazil and other dispositions and updates, and of others non-European Countries of final product's destination.

CUSTOMER SERVICE

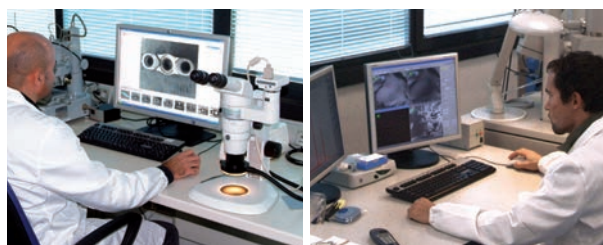

COMPETENCE AND RELIABILITY

Our Service department is always on hand to provide information about products and solve any issues thanks to technicians and engineers who are under continuing professional update.



PROMPTNESS OF DELIVERY

Careful management and an advanced logistics system allow the process of orders in a timely manner and deliver the goods to the carrier on average within 24 hours.

LEONE NEWSLIST

Keep informed with the latest news of our products: click on "Services" in our website www.leone.it and fill in the registration form.



TECHNICAL AND COMMERCIAL ASSISTANCE



CONTACT YOUR DEALER IN YOUR COUNTRY AS A REFERENCE.
YOU WILL FIND THE COMPREHENSIVE LIST UNDER THE SECTION
"DISTRIBUTORS" IN OUR WEBSITE

www.leone.it

A		
360° Anatomical abutments Standard and Large	50..52	
Abutment Gauges	94	
Abutment seater	95	
Abutment seater Double Force	95	
All-on-Four surgical guide	16	
Analogs	55	
B		
Ball head abutments	84..86	
Basic abutments Standard and Large	49	
Bonding cylinders for MUA	74	
Bone condenser tips	33	
Bone grafting tips	33	
Bone Profiler	26	
Burn-out coping for Ti-Base for ExaConnect	66	
C		
CAD-CAM interfaces for MUA	74	
Conic adapters for MUA	78..80	
Connecting rings	23	
Connecting screw for ExaConnect	66	
Connecting screws for MUA	75	
Countersinks	20	
D		
Demonstration Jumbo dental implant	100	
Depth gauge	24-155	
Depth stops	21	
Digital analogs	57	
Digital analogs for MUA	73	
Drill extension	22	
Drill stop kit	21	
E		
ExaConnect	60..62	
ExaConnect analog	64	
ExaConnect Plus - sterile	60-61-63	
Extension for instruments	23	
F		
Fan-type wrench for monoimplant	160	
Fixed caps	79-81	
G		
Grommets	29	
H		
Handle for abutments	98	
Handpiece adapter for monoimplants	156	
Handpiece adapter	23	
Handpiece screwdriver	97	
Healing caps Standard and Large	36-37	
Healing screw for ExaConnect	64	
Healing screws for MUA	72	
Hemi-mandible	100	
Hex head extractor	25-96	
Hexagons for 360° abutments	52	
High burn-out cylinders for MUA	74	
High Torque driver	23	
Housing with medium insert orange	87	
Housing with O-ring	88-154	
Housing with rigid insert violet	87	
Housing with soft insert white	87	
I		
Implant card	100	
Insert seating tool	88	
Instrument for cover caps	25	
L		
Lab and scan Ti-Base for ExaConnect	65	
Lance drill	19	
Light caps	79-81	
M		
Measuring pin for gingival height	25-155	
Medium insert orange	87	

Micro housing with micro O-ring	88-154
Micro O-ring	88-154
Mobile caps	79-81
Monoimplants for O-ring overdenture	152..156
MUA	68..70
MUA analogs	73
MUA Plus – sterile	68-69-71
MUA-Conic analogs	82
MUA-Conic transfer	82
Mucosa punch for contra-angle	26
Mucosa punch for contra-angle for monoimplants	155
Multifunctional screw for ExaConnect	66
Multifunctional screw for MUA	75
MultiTech abutments	53

O

Offset adapter for threaded handle	34
Organizer for Abutment Gauges	94
Organizer for implants and instruments	30-31
Organizer for monoimplants	155
O-ring	88
Osteotomy instrument kit	32

P

Paralleling pin	24
Patient information brochure	100
Pick-up transfer for ExaConnect	64
Pick-up transfer for MUA	72
Pilot drills	19
Pilot drills with integrated depth stop	22
Positioner for Scan Body for MUA	73
Positioner for Standard transfers	55
Prosthetic hand screwdriver	97
Prosthetic instrument kit	92-93
Prosthetic torque wrench 20 Ncm	97

R

Ratchet	24
Ratchet adapter for monoimplants	156
Removal tool for abutments	96
Repositionable transfer for ExaConnect	64
Repositionable transfer for MUA	72
Rigid insert violet	87
Round bur	19

S

Scan Body for MUA	73
Scan Body Inclined Plane	56-65
Scan Body Pyramid	56-65
Scan Post	56
Scan Post positioner	57
Screw adapters	97
Seating tips	95
Sinus lift tips	33
Slim healing screws for MUA	72
Soft insert white	87
Standard burn-out cylinders for MUA	74
Surgical demonstration kit	100
Surgical hand screwdriver	24
Surgical kits	27..29
Surgical mallet	34

T

Taps for 6.5 Short implant	22
Taps for Classix implants	22
Template	16
Template for monoimplants	156
Temporary abutment for ExaConnect	66
Temporary abutments Standard and Large	48
Threaded handle	34
Ti-Base abutment for ExaConnect	65
Ti-Base abutments	54
Tip wrench	34
Titanium basin	25
Titanium wires for welding	75-82
Torque screwdriver for laboratory 20 Ncm	98
Transfers Standard and Large	55
Twist drills	19
Twist drills for hard bone	20

W

Weingart style pliers	96
Weld caps	79-82
Welding cylinders for MUA	75

X

XCN® 2.9 Narrow implants	14-15
XCN® 6.5 Short implant	14-15
XCN® Classix implants	10-11
XCN® Max Stability implants	12-13



ISTITUTO STUDI ODONTOIATRICI



EDUCATION, TRAINING, UPGRADE

ISO Istituto Studi Odontoiatrici, the scientific division and training center of the Leone Company, operates throughout the national territory with the aim of spreading knowledge and promotion of dentistry and implant dentistry at ever higher levels.



Founded in 1982, the Florence office is divided over two floors, with a total area of 1,000 square meters and in almost 40 years of activity, it has hosted over 50,000 participants on its courses.

ISO offers a complete program of residential and online courses for dental-surgeons, dentists, specialists in dentistry and orthodontics. Dedicated training courses are also organized for dental technicians and to the product knowledge of orthodontics and implant dentistry, for Italian and foreign traders.



A STATE-OF-THE ART FACILITY

In addition to the welcoming premises reserved for reception and secretarial services, the first floor of the building is completely dedicated to lecture rooms:

- one dental practice equipped with 3 dental units for live demonstrations of orthodontic and implant interventions on patients
- one lecture hall seating up to 40 participants for doctors participating in live demonstrations
- endoral and extraoral cameras connected to the network make all the interventions visible in real time in the various classrooms
- one fully equipped dental laboratory with 18 benches
- one multi-purpose classroom for 80 trainees recently endowed with Active Classroom environment: an integrated Active Board multimedia interactive whiteboard and Active Expressions learner response system with real-time student assessment during the course.

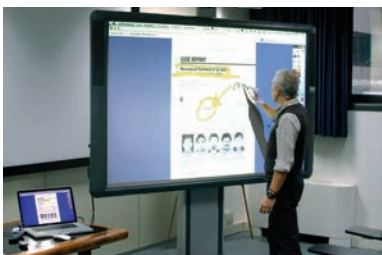

On the second floor:

- the "Marco Pozzi" Lecture Hall seating up to 250 congress participants. The hall is equipped with all multimedia devices.

The didactic tools available at ISO and the high qualified lecturers make any event a profitable and memorable one for every participant.



WWW.LEONE.IT/ENGLISH/IMPLANTOLOGY/VIDEO/PROCEDURE.PHP

VISIT THE NEW SECTION ON OUR WEBSITE!
VIEW VIDEO TUTORIALS OF PROSTHETIC PROCEDURES



WWW.LEONE.IT/PUBLICATIONS

IN THIS SECTION ARE COLLECTED ALL THE ARTICLES PUBLISHED ON THE EXACONE NEWS FROM 2004 TO TODAY.

It is possible to search by author, keyword or publication. Currently there are 212 articles and 5.900 images. An English version of some of the articles is available.



WWW.LEONE.IT/ENGLISH/SERVICES/PUBLICATION-IMPLANTOLOGY.PHP

LINKS TO ABSTRACTS OF SCIENTIFIC PUBLICATIONS AVAILABLE ONLINE

WWW.LEONE.IT/ENGLISH/ISO

FOLLOW US ONLINE TO STAY UP TO DATE ON ALL SCHEDULED COURSES
OR CONTACT THE ISO SECRETARIAT:

PHONE +39 055.304458 - ISO@LEONE.IT





























Follow us
on Facebook
and Instagram



PRODUCT LABEL SYMBOLS







The label on the package of any medical device set on the market will show the symbols in compliance with the harmonized standards. The symbols marked with a single (*) are based on the ISO 21531, ISO 15223-1, the 93/42EEC Directive and Regulation (EU) 2017/745. The symbols marked with double (**) have been instead adapted by Leone.

manufacturer's trade name and address	 (*)	catalogue code	 (*)	code number and product description in different languages
CE mark (made in compliance with 93/42EEC Directive on class IIA or IIB medical devices)	 (*)	expiry date, if the product is perishable (year/month/day)	 (*) 2030-12-31	storage temperature  (*)
lot number* (indicated by LOT mark)	 (*)	for professional use only	 (**)	for single use only  (*)
keep dry	 (*)	this product contains Nickel-Chromium: possible allergic reactions	 (**)	keep away from sunlight  (*)
CE mark (made in compliance with 93/42EEC Directive or Reg. (UE) 2017/745 on Class I medical devices)	 (*)	read the documents enclosed	 (*)	gamma-ray sterilized  (*)
titanium	 (*)	surgical steel	 (*)	this product contains Chromium: possible allergic reactions  (*)
autoclavable at temperature indicated	 (*)	polyethylene	 (*)	non-sterile  (*)
do not use if package is damaged	 (*)	polyetheretherketone	 (*)	UDI Barcode / UDI Datamatrix Unique Device Identification "UDI" for the identification and the traceability of the medical device
read the instructions for use enclosed	 (*)	with content or presence of natural rubber latex	 (*)	
read the digital instructions for use available at the specified website	 (*) www.leone.it	medical device	 (*)	 (01) 08033707071846 (10) 19021101 (91) 196C000001 (240) 110-3308-02 (17) 260211 UDI (*)

*Unless otherwise indicated, the LOT number explains the date of manufacture with the key YYMMDDNN (YY year, MM month, DD day, NN Leone progressive internal number of the lot).
For example 19021502 indicates the lot no. 02 of February 15, 2019

SYMBOLOLOGY

Various symbols are used throughout this catalogue to highlight product specifications as follows:

height	H	connection colour coding 2.2 mm		with integral hexagon	
length	L	connection colour coding 3.0 mm		without hexagon	
diameter	∅	instrument with 1 notch		with 360° hexagon	
thread diameter	M	instrument with 2 notches			

INFORMATION NOTE FOR DISTRIBUTORS: EUROPEAN REGULATION ON MEDICAL DEVICES, TRACEABILITY AND NEW REQUIREMENTS.

The **European Regulation (EU) 2017/745 on Medical Devices (MDR)**, came into force on May 26, 2021, imposes compliance obligations not only on manufacturers but also on all other economic operators in the supply chain, such as "distributors" (in the sense of what is specifically defined in the regulation itself), with regard to verification, traceability and post-marketing surveillance (e.g. notification to the manufacturer of any non-compliance, complaints or suspected incidents). For further information, please visit the following web site: <https://ec.europa.eu/docsroom/documents/33862> where you can find a factsheet issued by the European Commission, available in every language for any Member State. Among the range of dental devices supplied by Leone Spa, there are also products that qualify as **medical devices for dental use**, and, as a retailer of the aforementioned products, your organization will assume the qualification of "distributor", in accordance with the aforementioned regulation. Among responsibilities of distributor (Art. 14 of the MDR), there is the traceability of medical devices (Art. 25 of the MDR), which must be documented and made available for the control of the competent authorities, up to 15 years for implantable medical devices and 10 years for other dental medical devices. Leone S.p.a. has always paid the utmost attention to compliance with current regulations. We therefore take this opportunity to remind you of the importance of respecting the new legislative regulations in order to ensure the continuity of our mutual commercial relations.

Leone s.p.a. does not assume risk and liability resulting from the use of the products listed in this catalogue. Since they are intended for implanto-prosthetic use only, their use has to be restricted to skilled and licensed professionals, who will be held the sole responsible for the construction or the application of any implanto-prosthetic appliance partially or fully manufactured with the above mentioned products. All Leone products are designed and manufactured for single use and once removed from the patient's mouth, must be disposed of properly. Leone s.p.a. disclaims any liability for the spread of disease or personal injury caused by reuse.

Safety data sheets of our products can be downloaded from our web site: www.leone.it

HOW TO REACH LEONE

**BY AIRPLANE**

from the Peretola airport "A. Vespucci", five minutes by taxi.

BY CAR

- from the highway "Autostrada del Sole", exit Firenze Aeroporto, in the direction of Florence.
- Along the highway A11, exit Sesto Fiorentino, on your right side the Novotel and Ibis Hotel can be seen.
- At the second traffic circle, turn on the first exit on the right (McDonald's).

Coordinate GPS: +43° 48' 4.85" N, +11° 11' 0.23" E

BY TRAIN

from the central station "Santa Maria Novella", take bus no. 30, get off in Via Pratese near the car dealer Volkswagen.



Call **+39 055.3044620**

or send an e-mail message to **export@leone.it** for further information on Leone products or a visit to our factory.

You can also visit our website **www.leone.it**

Layout and realization by: Graphic department of Leone S.p.a
Printed by: ABC TIPOGRAFIA s.r.l. Calenzano, Firenze

Paper has a very significant impact on the environment. To get an idea of the effect that traditional paper has on the ecosystem, just think that it is necessary to cut down 15 trees to produce a ton of paper from virgin cellulose.

The format of this catalog has been re-sized to a smaller format. We have halved the use of paper for printing, saving up 50% on the costs and reducing environmental impact.

All rights reserved. No part of this catalogue may be reproduced in any form.

Due to continuing product improvements, Leone s.p.a. reserves the right to discontinue products or change the design and materials of products without notice.



ONLINE CATALOG